



# Cambridge International AS & A Level

CANDIDATE NAME



CENTRE NUMBER

--	--	--	--	--

CANDIDATE NUMBER

--	--	--	--

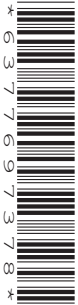

**PHYSICS**

**9702/23**

Paper 2 AS Level Structured Questions

**October/November 2024**

**1 hour 15 minutes**

You must answer on the question paper.

No additional materials are needed.

## INSTRUCTIONS

- Answer **all** questions.
- Use a black or dark blue pen. You may use an HB pencil for any diagrams or graphs.
- Write your name, centre number and candidate number in the boxes at the top of the page.
- Write your answer to each question in the space provided.
- Do **not** use an erasable pen or correction fluid.
- Do **not** write on any bar codes.
- You may use a calculator.
- You should show all your working and use appropriate units.

## INFORMATION

- The total mark for this paper is 60.
- The number of marks for each question or part question is shown in brackets [ ].

This document has **16** pages. Any blank pages are indicated.



**Data**

acceleration of free fall	$g = 9.81 \text{ m s}^{-2}$
speed of light in free space	$c = 3.00 \times 10^8 \text{ m s}^{-1}$
elementary charge	$e = 1.60 \times 10^{-19} \text{ C}$
unified atomic mass unit	$1 \text{ u} = 1.66 \times 10^{-27} \text{ kg}$
rest mass of proton	$m_p = 1.67 \times 10^{-27} \text{ kg}$
rest mass of electron	$m_e = 9.11 \times 10^{-31} \text{ kg}$
Avogadro constant	$N_A = 6.02 \times 10^{23} \text{ mol}^{-1}$
molar gas constant	$R = 8.31 \text{ J K}^{-1} \text{ mol}^{-1}$
Boltzmann constant	$k = 1.38 \times 10^{-23} \text{ J K}^{-1}$
gravitational constant	$G = 6.67 \times 10^{-11} \text{ N m}^2 \text{ kg}^{-2}$
permittivity of free space	$\epsilon_0 = 8.85 \times 10^{-12} \text{ F m}^{-1}$ $\left(\frac{1}{4\pi\epsilon_0} = 8.99 \times 10^9 \text{ m F}^{-1}\right)$
Planck constant	$h = 6.63 \times 10^{-34} \text{ J s}$
Stefan–Boltzmann constant	$\sigma = 5.67 \times 10^{-8} \text{ W m}^{-2} \text{ K}^{-4}$

**Formulae**

uniformly accelerated motion	$s = ut + \frac{1}{2}at^2$ $v^2 = u^2 + 2as$
hydrostatic pressure	$\Delta p = \rho g \Delta h$
upthrust	$F = \rho g V$
Doppler effect for sound waves	$f_o = \frac{f_s v}{v \pm v_s}$
electric current	$I = Anvq$
resistors in series	$R = R_1 + R_2 + \dots$
resistors in parallel	$\frac{1}{R} = \frac{1}{R_1} + \frac{1}{R_2} + \dots$



\* 000800000003 \*



BLANK PAGE

DO NOT WRITE IN THIS MARGIN





1 (a) Define acceleration.

.....  
..... [1]

(b) A small aircraft is flying horizontally at a speed of  $42 \text{ m s}^{-1}$  at a height of  $63 \text{ m}$  above horizontal ground, as shown in Fig. 1.1.

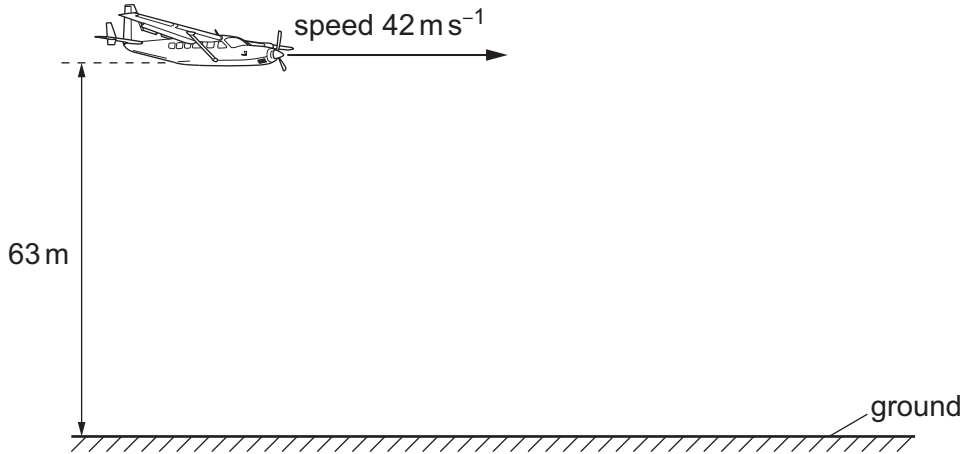

Fig. 1.1

The aircraft drops a small parcel. The parcel is released from the aircraft at the instant shown in Fig. 1.1. Air resistance is negligible.

- (i) On Fig. 1.1, draw a line to show the path of the parcel as it falls from the aircraft to the ground. [1]
- (ii) Calculate the time taken from the instant of release to the instant the parcel reaches the ground.

time = ..... s [2]





(iii) Calculate the vertical component of the velocity of the parcel immediately before it reaches the ground.

vertical component of velocity = .....  $\text{ms}^{-1}$  [1]

(iv) Determine the speed at which the parcel reaches the ground.

speed = .....  $\text{ms}^{-1}$  [2]

[Total: 7]

DO NOT WRITE IN THIS MARGIN





2 (a) State the principle of conservation of momentum.

.....  
.....  
..... [2]

(b) A ball X has mass 240 g and moves in a straight line on a horizontal frictionless surface with an initial speed of  $16 \text{ m s}^{-1}$ . The ball collides with a stationary ball Y that has mass 480 g. After the collision, ball X is stationary, as shown in Fig. 2.1.

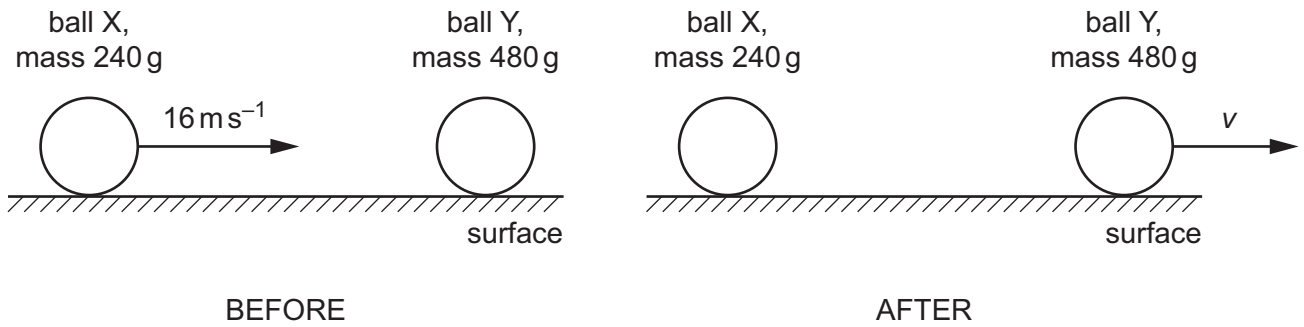

Fig. 2.1

(i) Show that the speed  $v$  of ball Y after the collision is  $8.0 \text{ m s}^{-1}$ .

[1]

(ii) Calculate the change in the total kinetic energy  $\Delta E_K$  of the balls due to the collision.

$\Delta E_K = \dots\dots\dots \text{ J [3]}$



DO NOT WRITE IN THIS MARGIN



(c) The collision in (b) lasts for a time of 2.0 ms. Assume that the contact force between the balls is constant during this time.

(i) Determine the magnitude and direction of the force exerted on ball X by ball Y during the collision.

magnitude = ..... N

direction .....

[3]

(ii) Compare the magnitude and direction of the force exerted on ball Y by ball X during the collision with the answers in (c)(i). No further calculations are required.

.....

.....

..... [2]

[Total: 11]

DO NOT WRITE IN THIS MARGIN





- 3 (a) State the principle of moments.

.....

.....

..... [1]

- (b) A rigid uniform beam rests on a pivot at its centre, as shown in Fig. 3.1.

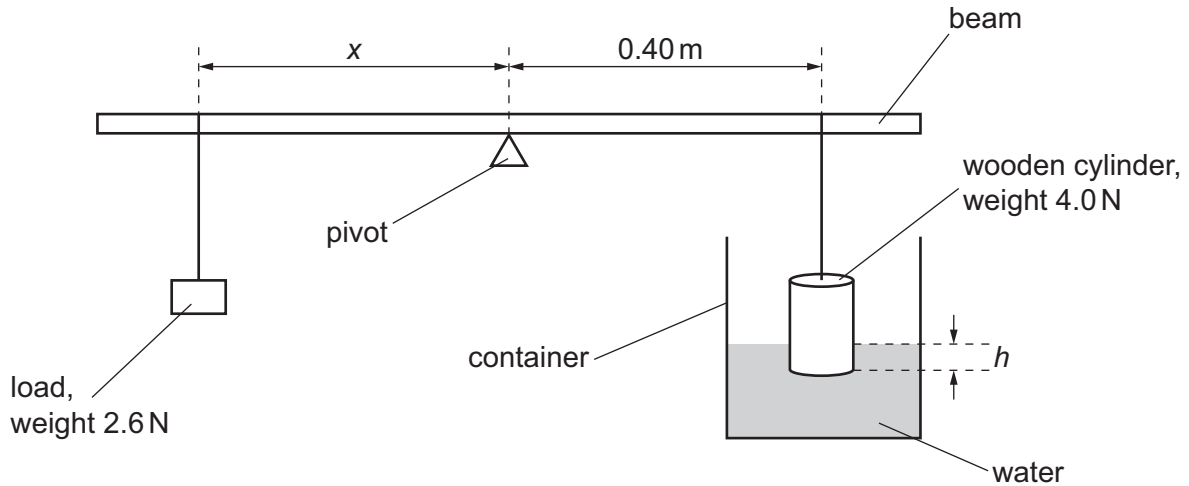

Fig. 3.1 (not to scale)

A load of weight 2.6 N is suspended from the beam at distance  $x$  from the pivot.

A wooden cylinder of weight 4.0 N is suspended from the beam at a distance of 0.40 m from the pivot on the opposite side of the pivot to the load. The cylinder rests in a container of water. The lower part of the cylinder is immersed in the water to depth  $h$ .

Initially,  $h$  is equal to 0.10 m and  $x$  is equal to 0.40 m. The system is in equilibrium.

- (i) Use the principle of moments to show that the upthrust  $U$  exerted by the water on the cylinder is 1.4 N.

[2]







(ii) The density of the water is  $1.0 \times 10^3 \text{ kg m}^{-3}$ .

Calculate the area  $A$  of the circular cross-section of the cylinder.

$A = \dots\dots\dots \text{ m}^2$  [3]

(c) More water is gradually added to the container in (b), so that depth  $h$  in Fig. 3.1 gradually increases. The length  $x$  is continuously adjusted so that the system remains in equilibrium.

On Fig. 3.2, sketch the variation of  $x$  with  $h$ . Use the space below for any working.

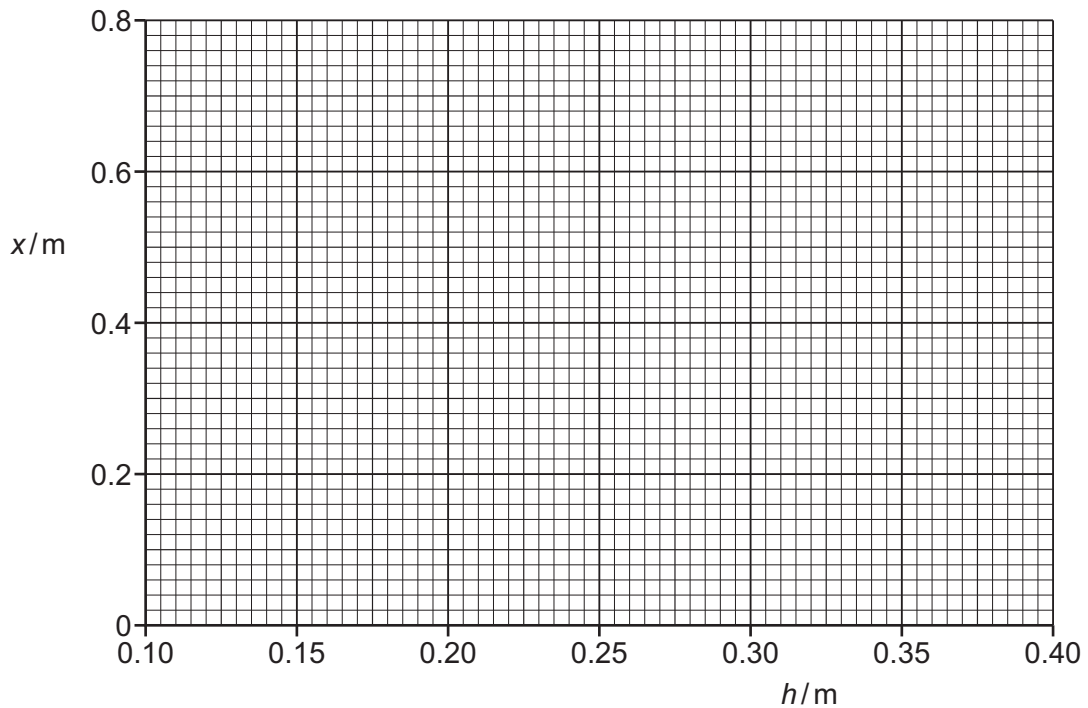

Fig. 3.2

[3]

[Total: 9]



DO NOT WRITE IN THIS MARGIN



4 (a) Define:

(i) stress

.....  
..... [1]

(ii) strain.

.....  
..... [1]

(b) Two wires X and Y, with equal unstretched lengths of 0.84 m, are suspended from fixed points that are at the same horizontal level. The lower ends of the wires are attached to a beam of negligible mass. The beam is horizontal and in equilibrium, as shown in Fig. 4.1.

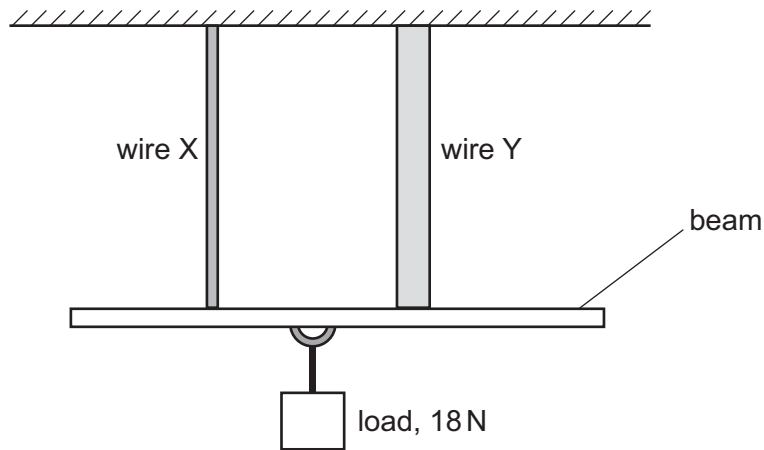

Fig. 4.1

Wire X is made from a metal that has a Young modulus of  $1.9 \times 10^9$  Pa.  
Wire Y is made from a different metal.

A load of weight 18 N is suspended from the beam at a point that is equidistant from the two wires. This load causes both wires to extend by 0.47 mm.





(i) Determine the cross-sectional area of wire X.

cross-sectional area = ..... m<sup>2</sup> [3]

(ii) Wire Y has a greater diameter than wire X.

Explain, without calculation, whether the Young modulus of the metal from which wire Y is made is less than, the same as or greater than  $1.9 \times 10^9$  Pa.

.....  
.....  
.....  
..... [2]

[Total: 7]

DO NOT WRITE IN THIS MARGIN





- 5 (a) A stationary wave is formed on a string XY that has a length of 0.48m. Fig. 5.1 shows the string at one instant in time.

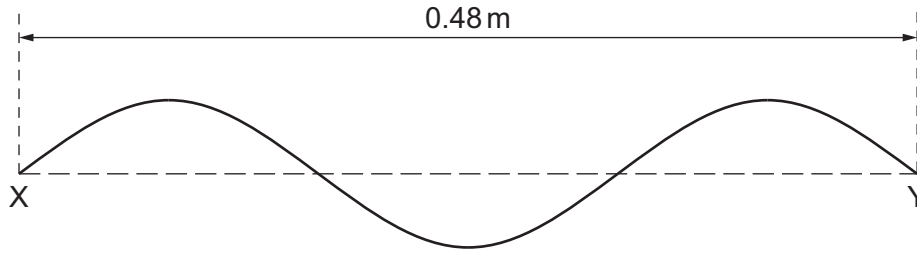

Fig. 5.1

The speed of the wave on the string is  $1400 \text{ ms}^{-1}$ .

- (i) On Fig. 5.1, draw a cross (x) at **one** position that is a node and another cross at **one** position that is an antinode. Label the node N and the antinode A. [1]
- (ii) Show that the wavelength of the wave produced is 0.32m. Explain your reasoning. [1]

- (iii) Calculate the frequency of the wave.

frequency = ..... Hz [2]

DO NOT WRITE IN THIS MARGIN





- (b) A source of sound waves of frequency 780 Hz is on a rotating platform. The speed of the source is  $39 \text{ ms}^{-1}$ .

The sound is detected by an observer that is a large distance from the rotating platform, as shown in Fig. 5.2.

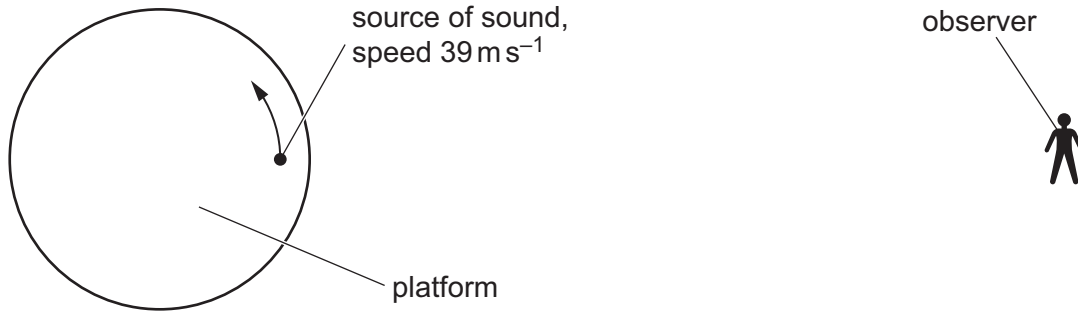

**Fig. 5.2** (not to scale)

- (i) The speed of sound in air is  $320 \text{ ms}^{-1}$ .

Calculate the maximum frequency of the sound detected by the observer.

maximum frequency = ..... Hz [2]

- (ii) At time  $t = 0$ , the observer detects the sound emitted by the source when it was in the position shown in Fig. 5.2.

On Fig. 5.3, sketch the variation with  $t$  of the frequency  $f$  of the sound detected by the observer for one complete rotation of the platform. Calculations are not required.

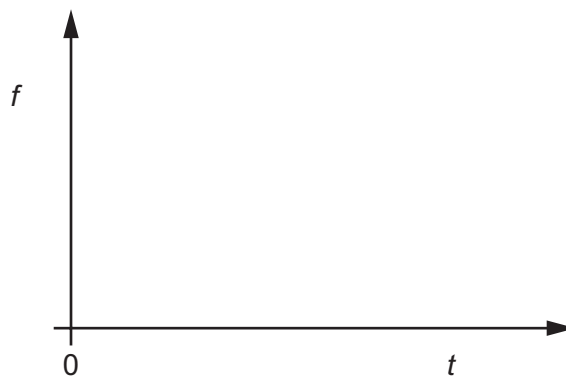

**Fig. 5.3**

[2]

[Total: 8]



DO NOT WRITE IN THIS MARGIN



6 (a) Define resistance.

.....  
..... [1]

(b) A cylindrical metal wire of length 2.4 m and cross-sectional area  $8.0 \times 10^{-6} \text{ m}^2$  has a resistance of  $0.33 \Omega$ . There is a current in the wire of 4.7 A.

(i) Determine the resistivity of the metal from which the wire is made.

resistivity = .....  $\Omega \text{ m}$  [2]

(ii) Calculate the charge that passes through the wire in a time of 5.0 minutes.

charge = ..... C [2]

(iii) The free electrons (charge carriers) in the wire have an average drift speed of  $0.16 \text{ mm s}^{-1}$ .

Determine the number density of charge carriers in the metal.

number density = .....  $\text{m}^{-3}$  [2]

DO NOT WRITE IN THIS MARGIN

DO NOT WRITE IN THIS MARGIN

DO NOT WRITE IN THIS MARGIN

DO NOT WRITE IN THIS MARGIN

DO NOT WRITE IN THIS MARGIN





(c) The wire in (b) may be considered to be a fixed resistor. It is connected in series with a thermistor to a battery that has negligible internal resistance.

(i) Use circuit symbols to complete Fig. 6.1 to show the circuit diagram of this arrangement.

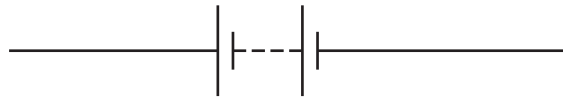

Fig. 6.1

[1]

(ii) Explain, without calculation, how the power dissipated in the wire changes as the temperature of the thermistor is increased.

.....  
.....  
.....  
..... [2]

[Total: 10]

DO NOT WRITE IN THIS MARGIN





7 (a) Complete Table 7.1 to show the charges, in terms of the elementary charge  $e$ , on each of the flavours of quark and antiquark shown.

Table 7.1

flavour	charge / $e$	
	quark	antiquark
up		
down		
strange		

[3]

(b) (i) State the name of the class (group) of fundamental particles to which baryons and mesons belong.

..... [1]

(ii) Compare baryons and mesons in terms of their constituent particles.

.....  
.....  
..... [2]

(c) Describe  $\beta^+$  decay in terms of the fundamental particles involved.

.....  
.....  
.....  
..... [2]

[Total: 8]

Permission to reproduce items where third-party owned material protected by copyright is included has been sought and cleared where possible. Every reasonable effort has been made by the publisher (UCLES) to trace copyright holders, but if any items requiring clearance have unwittingly been included, the publisher will be pleased to make amends at the earliest possible opportunity.

To avoid the issue of disclosure of answer-related information to candidates, all copyright acknowledgements are reproduced online in the Cambridge Assessment International Education Copyright Acknowledgements Booklet. This is produced for each series of examinations and is freely available to download at [www.cambridgeinternational.org](http://www.cambridgeinternational.org) after the live examination series.

Cambridge Assessment International Education is part of Cambridge Assessment. Cambridge Assessment is the brand name of the University of Cambridge Local Examinations Syndicate (UCLES), which is a department of the University of Cambridge.



DO NOT WRITE IN THIS MARGIN