



Cambridge International Examinations
Cambridge International General Certificate of Secondary Education

BIOLOGY (US)

0438/11

Paper 1 Multiple Choice (Core)

October/November 2016

45 minutes

Additional Materials: Multiple Choice Answer Sheet
Soft clean eraser
Soft pencil (type B or HB is recommended)



READ THESE INSTRUCTIONS FIRST

Write in soft pencil.

Do not use staples, paper clips, glue or correction fluid.

Write your name, Center number and candidate number on the Answer Sheet in the spaces provided unless this has been done for you.

DO NOT WRITE IN ANY BARCODES.

There are **forty** questions on this paper. Answer **all** questions. For each question there are four possible answers **A, B, C** and **D**.

Choose the **one** you consider correct and record your choice in **soft pencil** on the separate Answer Sheet.

Read the instructions on the Answer Sheet very carefully.

Each correct answer will score one mark. A mark will not be deducted for a wrong answer.

Any rough working should be done in this booklet.

Electronic calculators may be used.

This document consists of **17** printed pages and **3** blank pages.

- 1 The diagram shows a plant that has been placed near a sunlit window for a few weeks.

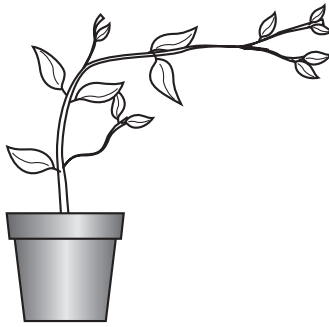

Which two characteristics of living organisms have affected the shape of the plant?

- A excretion and sensitivity
 - B growth and reproduction
 - C reproduction and excretion
 - D sensitivity and growth
- 2 What is a characteristic of amphibians but **not** of reptiles?
- A four limbs
 - B laying eggs in water
 - C scaly skin
 - D using lungs for breathing
- 3 The diagram shows an insect.

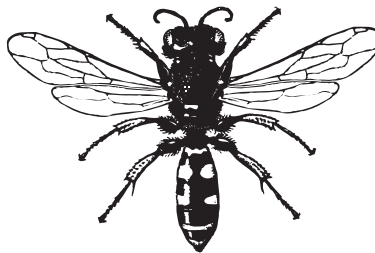

Use the key to identify the insect.

- 1 wings present go to 2
- wings absent **A**
- 2 two pairs of wings go to 3
- one pair of wings **B**
- 3 wings with circular markings **C**
- wings without circular markings **D**

- 4 The diagram shows a spongy mesophyll cell from a green leaf.

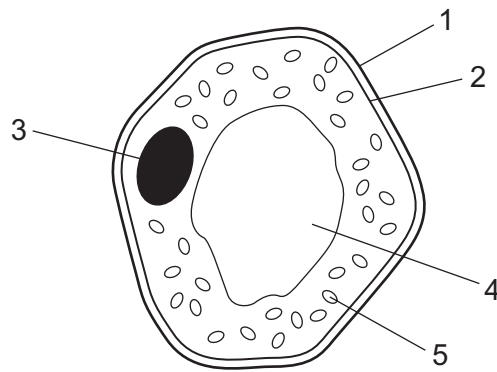

Which labeled structures are **not** found in animal cells?

- A** 1, 3 and 4 **B** 1, 4 and 5 **C** 2, 3 and 4 **D** 3, 4 and 5
- 5 What are the features of the cell walls in a xylem vessel?

	end wall	side wall
A	absent	thick
B	absent	thin
C	present	thick
D	present	thin

- 6 The diagram shows a plant cell which has lost water to its surroundings by osmosis.

Which part is the partially permeable membrane?

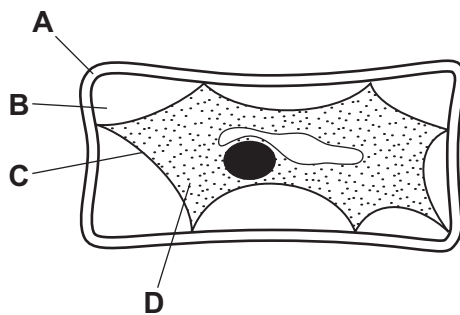

7 Which identifies the chemical elements found in proteins?

	carbon	hydrogen	oxygen	nitrogen
A	✓	✓	✓	✓
B	✓	✓	✓	x
C	✓	x	✓	x
D	x	✓	x	✓

key

✓ = present

x = absent

8 What controls the speed of chemical reactions in all living cells?

- A** enzymes
- B** hormones
- C** ions
- D** vitamins

9 Where are carbohydrates made in a green leaf?

- A** cell vacuoles
- B** chloroplasts
- C** phloem
- D** xylem

10 How does carbon dioxide pass through the stomata of a leaf?

- A** active transport
- B** diffusion
- C** osmosis
- D** transpiration

11 The roots of plants take up nitrates from the soil.

What are the nitrates used to make?

- A** fat
- B** glucose
- C** protein
- D** starch

12 A child decided to eat only meat, oily fish, cheese and bread, and drink only water.

Which nutrient would be in low levels in this diet?

- A calcium
- B iron
- C vitamin C
- D vitamin D

13 The diagram shows the human alimentary canal.

Which labeled part absorbs the most water?

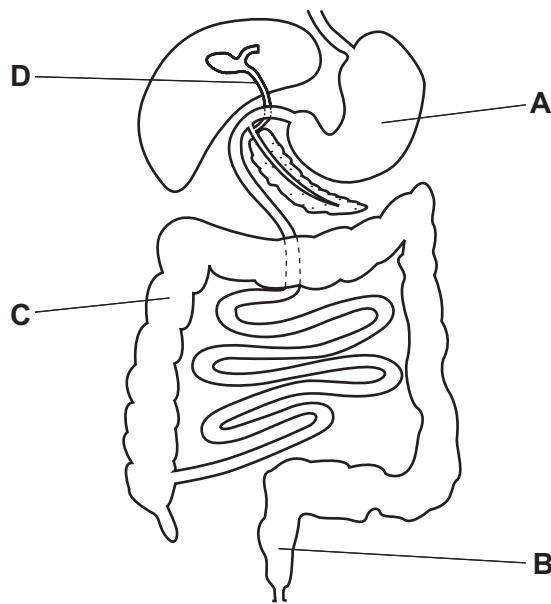

14 Which substances are produced by the action of amylase on starch?

- A amino acids
- B fatty acids and glycerol
- C salts
- D simple sugars

- 15 The diagram shows the stem of a plant. A strip of the outer tissue including the phloem has been removed.

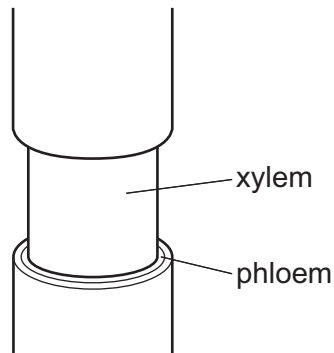

How is transport in the plant affected?

- A Amino acids and sugar cannot pass to the roots.
 - B Dissolved salts cannot pass to the leaves.
 - C Water cannot pass to the leaves.
 - D Water cannot pass to the roots.
- 16 The diagrams show stages in the passage of water through a plant.

Which arrow shows water moving in the form of water vapor?

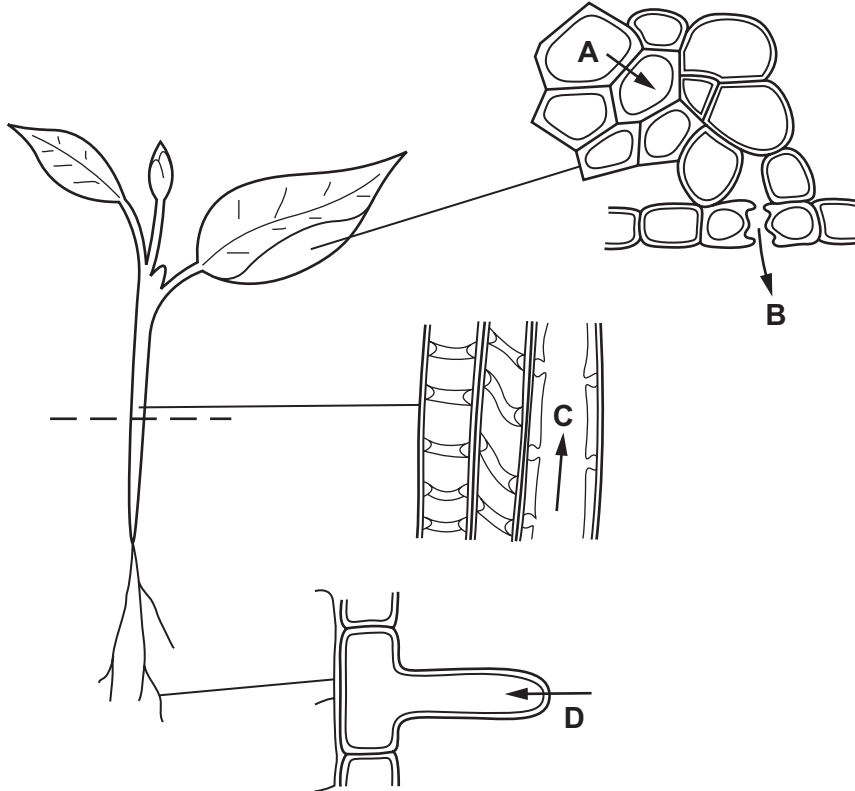

17 Which graph shows the effect of increasing humidity on the rate of transpiration?

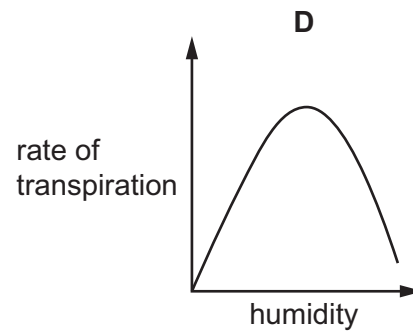
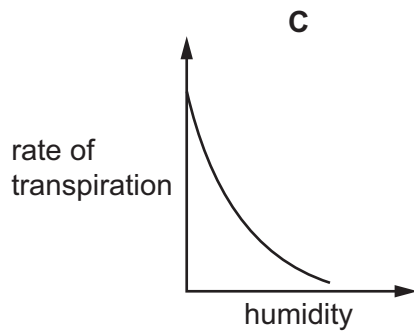
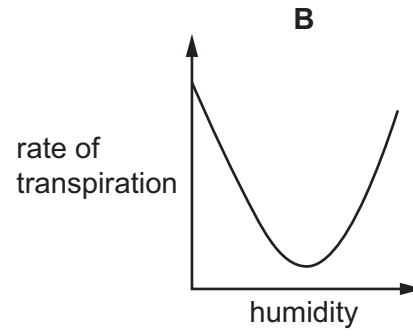
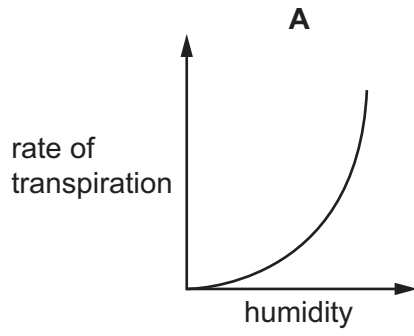

- 18 The diagram shows a garden pond with a fountain worked by a pump. The fountain brings oxygen from the air to fish in the pond.

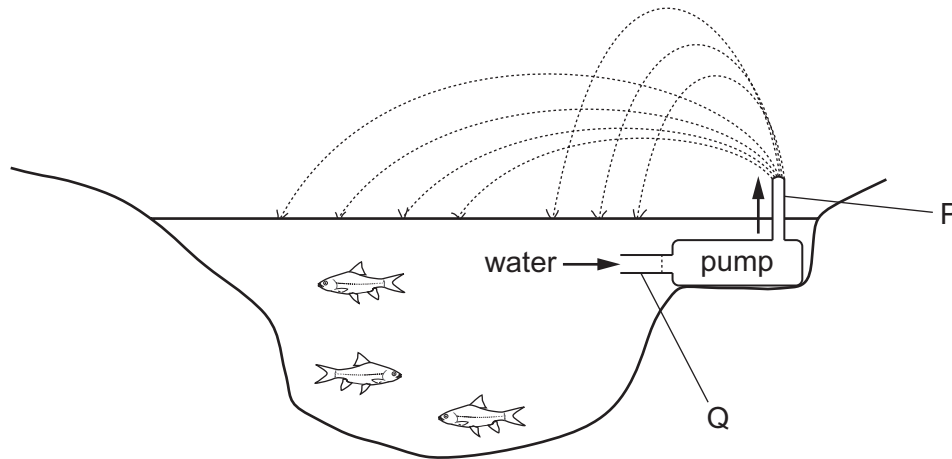

The system can be compared with part of the human circulatory system. The pump is compared with the heart.

What are P and Q compared with?

	P	Q
A	aorta	pulmonary artery
B	pulmonary artery	vena cava
C	pulmonary vein	vena cava
D	vena cava	aorta

- 19 The diagram shows sections through three types of blood vessel, **not** drawn to the same scale.

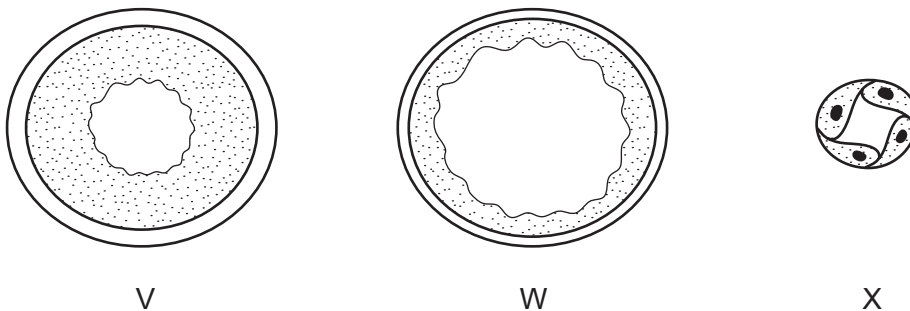

Which section is from a vein and which is from a capillary?

	vein	capillary
A	V	W
B	W	V
C	W	X
D	X	W

20 The diagram shows human blood cells, as seen under a microscope.

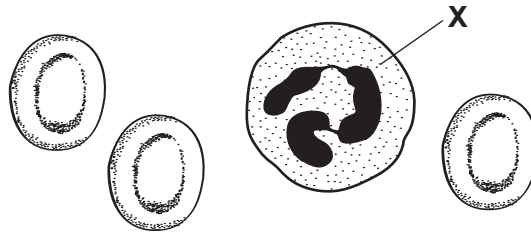

What is the function of cell X?

- A to carry glucose
- B to carry oxygen
- C to defend against disease
- D to make the blood clot

21 What is the approximate composition of the air breathed out by a person?

	oxygen %	carbon dioxide %
A	5	73
B	16	4
C	21	0.04
D	78	2

22 Which substances are produced by respiration in humans?

	carbon dioxide	alcohol (ethanol)	water	lactic acid
A	✓	✓	✓	x
B	✓	x	✓	✓
C	✓	x	x	✓
D	x	✓	✓	x

23 The apparatus shown is set up and left for one hour.

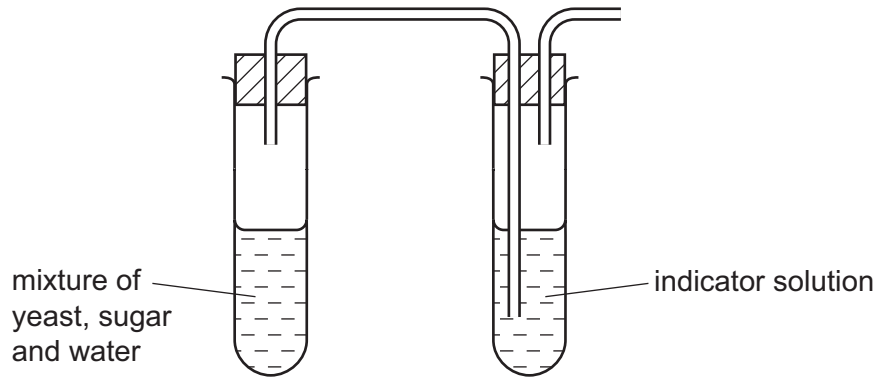

A gas is released by the mixture. It caused the indicator solution to go cloudy.

What is the indicator solution?

- A alcohol
- B Benedict's solution
- C biuret solution
- D limewater

24 A person is regularly connected to a machine that removes wastes, and excess salts and water, from their blood.

Which organ's function does the machine carry out?

- A bladder
- B kidney
- C liver
- D lung

25 The diagram shows the human nervous system.

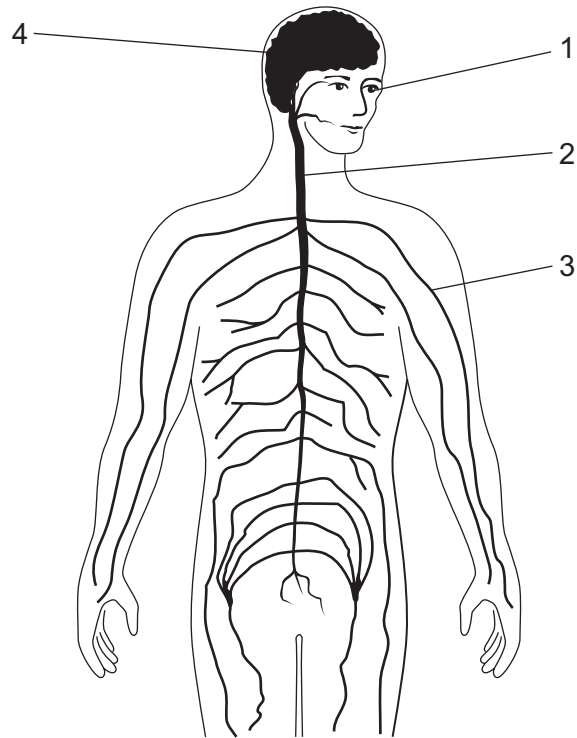

Which two structures form the central nervous system?

- A** 1 and 3 **B** 1 and 4 **C** 2 and 3 **D** 2 and 4

26 The flow diagram shows the pathway that causes pupil diameter to decrease in response to bright light.

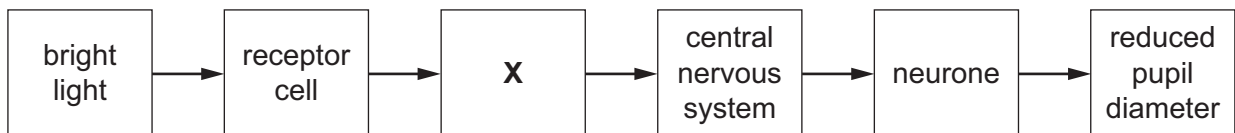

What does **X** represent?

- A** iris
B motor neurone
C relay neurone
D sensory neurone

27 The diagram shows seedlings in two experiments on the tropic response of seedlings to gravity and light.

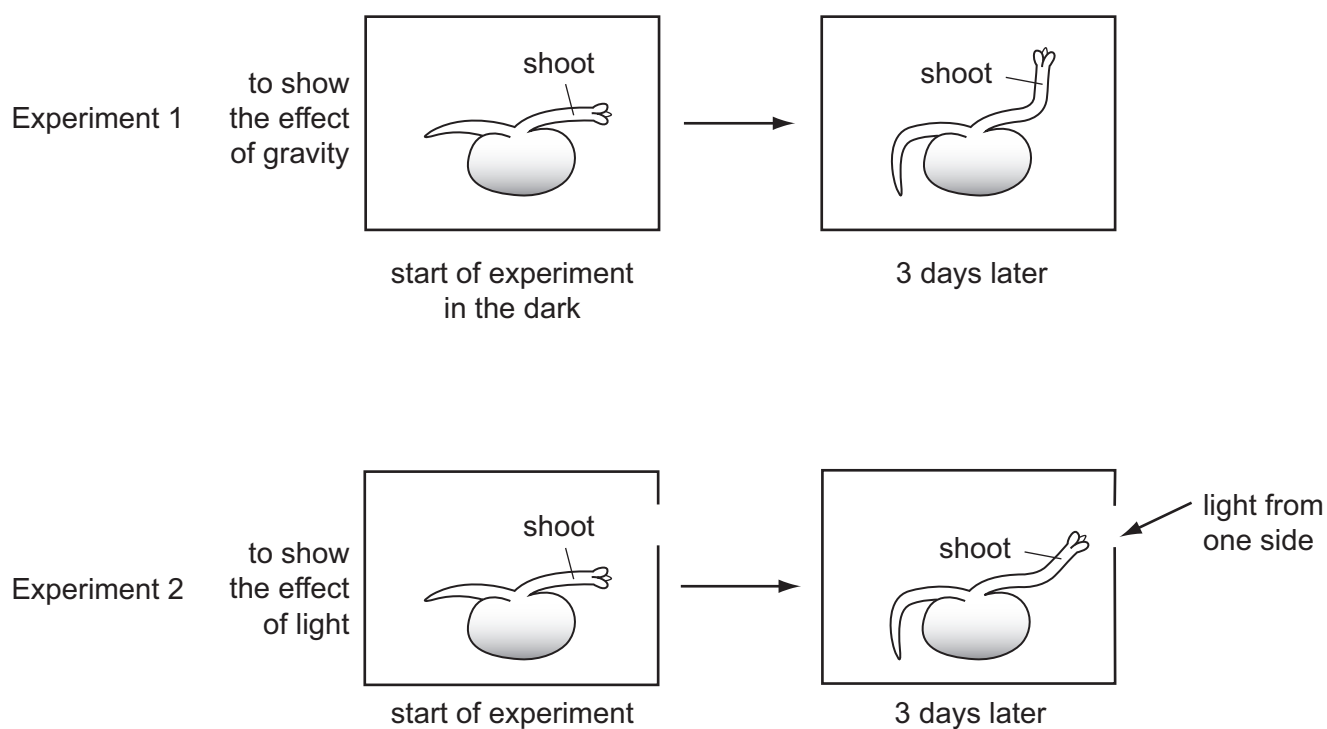

How have the seedlings responded?

	to gravity	to light
A	✓	✓
B	✓	✗
C	✗	✓
D	✗	✗

key

✓ = tropic response shown

✗ = no tropic response shown

28 When does fertilization occur in humans?

- A** when an egg is released
- B** when implantation occurs
- C** when sperm and egg nuclei fuse
- D** when sperm are released

29 The diagram shows part of the reproductive system of a human female.

In which labeled region would implantation of a zygote normally take place?

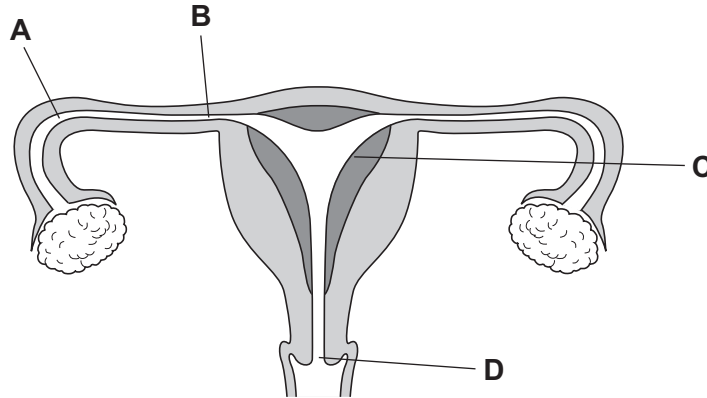

30 The diagrams show four methods of birth control.

Which one is placed in the uterus?

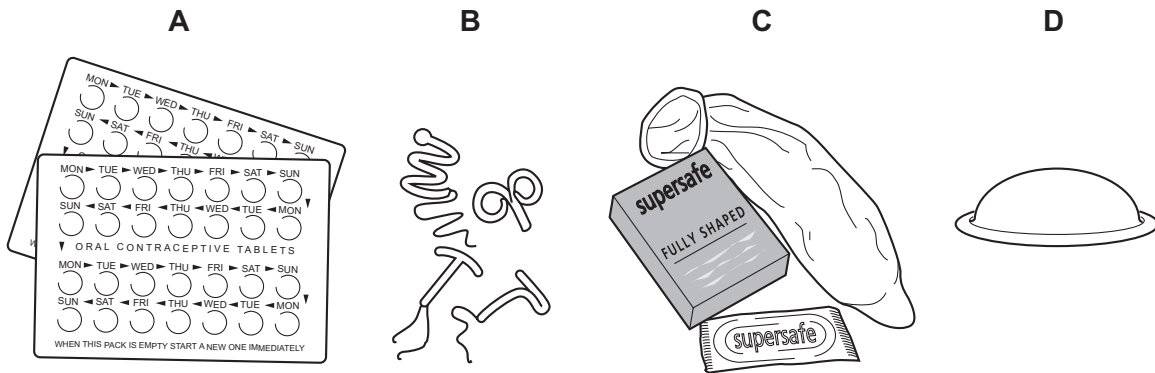

31 What is the definition of an allele?

- A a length of DNA that codes for a protein
- B a thread-like structure, carrying genes
- C a version of a gene
- D the genetic make up of an organism

32 Which row describes the cells produced in meiosis, and a function of this type of nuclear division?

	cells produced	function
A	genetically different	asexual reproduction
B	genetically different	sexual reproduction
C	genetically identical	asexual reproduction
D	genetically identical	sexual reproduction

33 A brown mouse mates with a white mouse. There are 8 brown mice and 9 white mice in the offspring.

The same two mice mate again. There are 9 brown mice and 7 white mice in the offspring.

What are the genotypes of the parents most likely to be?

- A heterozygous \times heterozygous
 - B homozygous dominant \times heterozygous
 - C homozygous dominant \times homozygous recessive
 - D homozygous recessive \times heterozygous
- 34 What is the principal source of energy input into a food chain?
- A primary consumer
 - B producer
 - C secondary consumer
 - D the Sun

35 The diagram shows a food web.

Which arrow does **not** show the direction of energy flow?

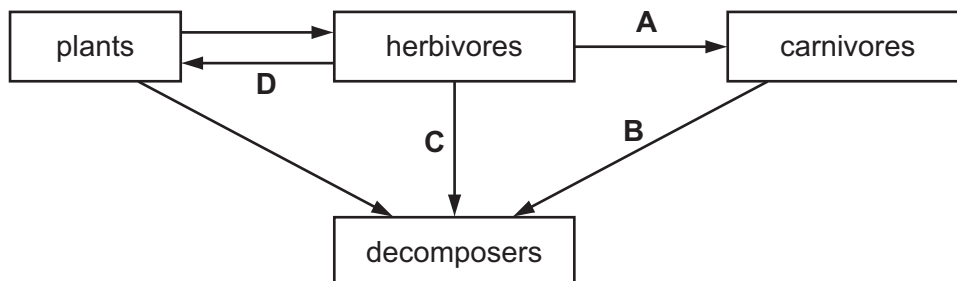

36 The diagram shows part of the carbon cycle.

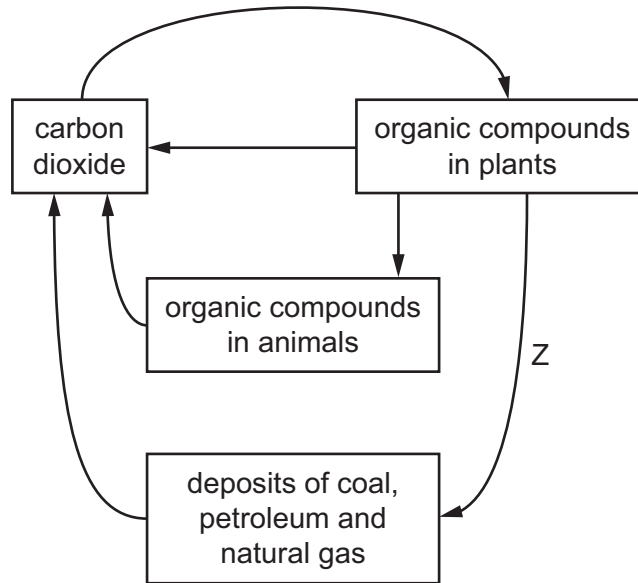

What is the process labeled Z?

- A** decomposition
- B** fossilization
- C** photosynthesis
- D** respiration

- 37 The graph shows the population of mosquito larvae in a pond. On day 3, fish that eat mosquito larvae are released into the pond.

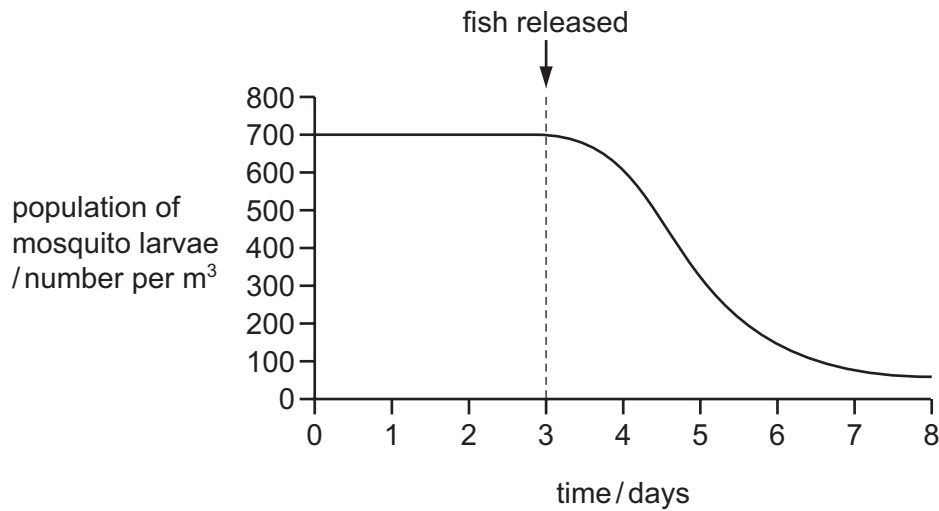

What is the most likely reason for the decline in the population of larvae after day 3?

- A disease
 - B lack of oxygen
 - C old age
 - D predation
- 38 Why is yeast used in bread-making?
- A Aerobic respiration produces alcohol.
 - B Aerobic respiration produces lactic acid.
 - C Anaerobic respiration produces alcohol.
 - D Anaerobic respiration produces carbon dioxide.
- 39 Which agricultural activity does **not** result in pollution of nearby rivers?
- A adding artificial fertilizers
 - B digging plant material into the soil
 - C spraying with herbicides
 - D spraying with insecticides

- 40 The diagram shows the results of a survey on the types of animals found along a stretch of river near to a factory.

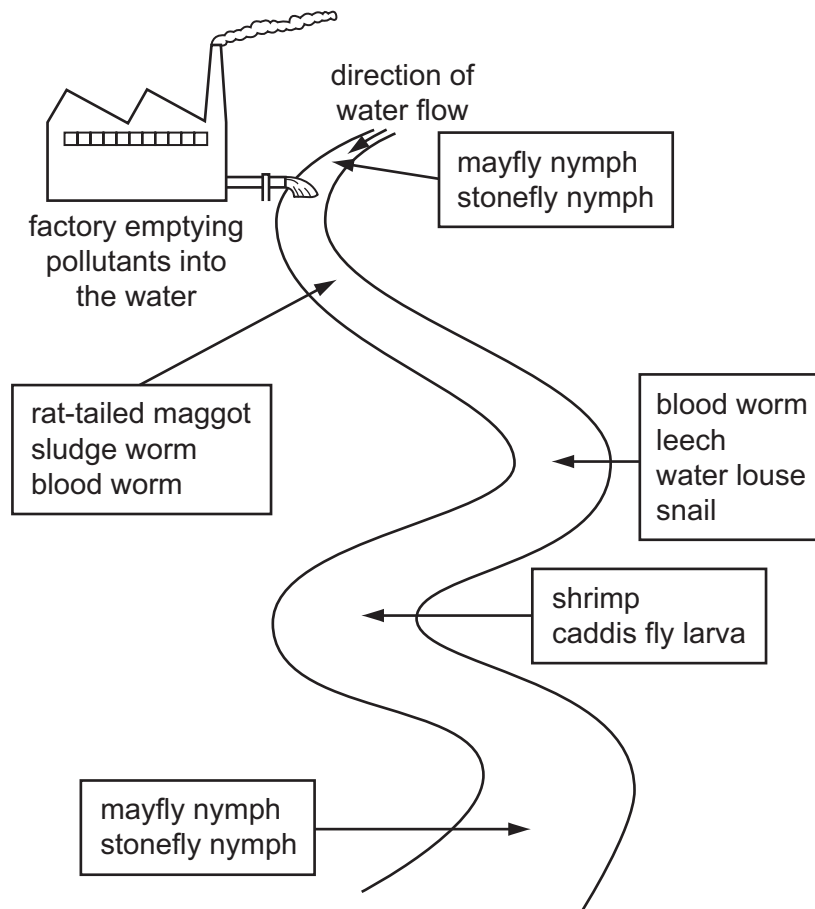

Which of the following animals lives in the most polluted water?

- A blood worm
- B caddis fly larva
- C leech
- D stonefly nymph

BLANK PAGE

Permission to reproduce items where third-party owned material protected by copyright is included has been sought and cleared where possible. Every reasonable effort has been made by the publisher (UCLES) to trace copyright holders, but if any items requiring clearance have unwittingly been included, the publisher will be pleased to make amends at the earliest possible opportunity.

To avoid the issue of disclosure of answer-related information to candidates, all copyright acknowledgements are reproduced online in the Cambridge International Examinations Copyright Acknowledgements Booklet. This is produced for each series of examinations and is freely available to download at www.cie.org.uk after the live examination series.

Cambridge International Examinations is part of the Cambridge Assessment Group. Cambridge Assessment is the brand name of University of Cambridge Local Examinations Syndicate (UCLES), which is itself a department of the University of Cambridge.