



Cambridge International Examinations
Cambridge International General Certificate of Secondary Education

CHEMISTRY (US)

0439/11

Paper 1 Multiple Choice

October/November 2015

45 Minutes

Additional Materials: Multiple Choice Answer Sheet
 Soft clean eraser
 Soft pencil (type B or HB is recommended)

* 4 7 2 4 5 0 5 0 5 2 *

READ THESE INSTRUCTIONS FIRST

Write in soft pencil.
Do not use staples, paper clips, glue or correction fluid.
Write your name, Center number and candidate number on the Answer Sheet in the spaces provided unless this has been done for you.
DO NOT WRITE IN ANY BARCODES.

There are **forty** questions on this paper. Answer **all** questions. For each question there are four possible answers **A, B, C** and **D**.
Choose the **one** you consider correct and record your choice in **soft pencil** on the separate Answer Sheet.

Read the instructions on the Answer Sheet very carefully.

Each correct answer will score one mark. A mark will not be deducted for a wrong answer.
Any rough working should be done in this booklet.
A copy of the Periodic Table is printed on page 20.
Electronic calculators may be used.

This document consists of **17** printed pages and **3** blank pages.

1 Diagrams X, Y and Z represent the three states of matter.

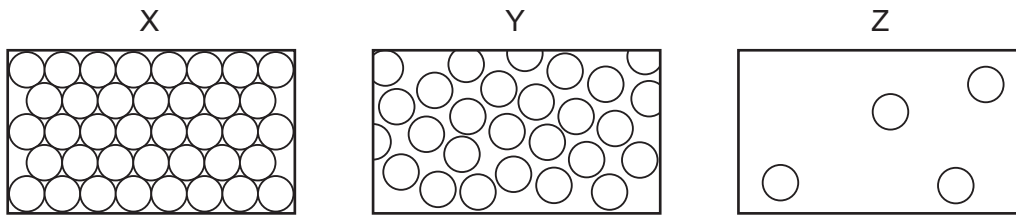

Which change occurs during boiling?

- A** X to Y **B** Y to Z **C** Z to X **D** Z to Y

2 P, Q, R and S are pieces of apparatus.

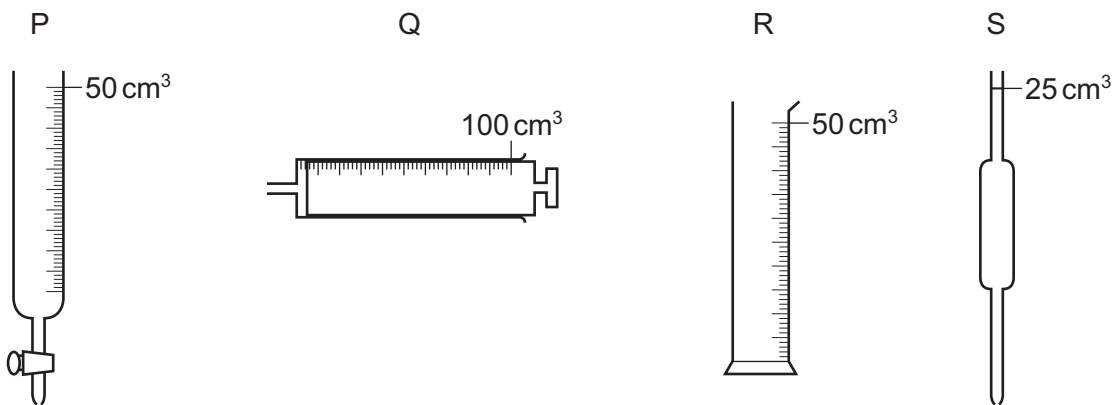

Which row describes the correct apparatus for the measurement made?

	apparatus	measurement made
A	P	the volume of acid added to alkali in a titration
B	Q	1 cm ³ of acid to add to calcium carbonate in a rate-determining experiment
C	R	75 cm ³ of a gas given off in a rate-determining experiment
D	S	20 cm ³ of alkali for use in a titration

3 Which statement about atoms is correct?

- A** Atoms contain protons and electrons in the nucleus.
B Neutrons are negatively charged.
C Protons are positively charged.
D The nucleon number is the number of neutrons.

4 Which diagram correctly shows the ions present in the compound potassium fluoride?

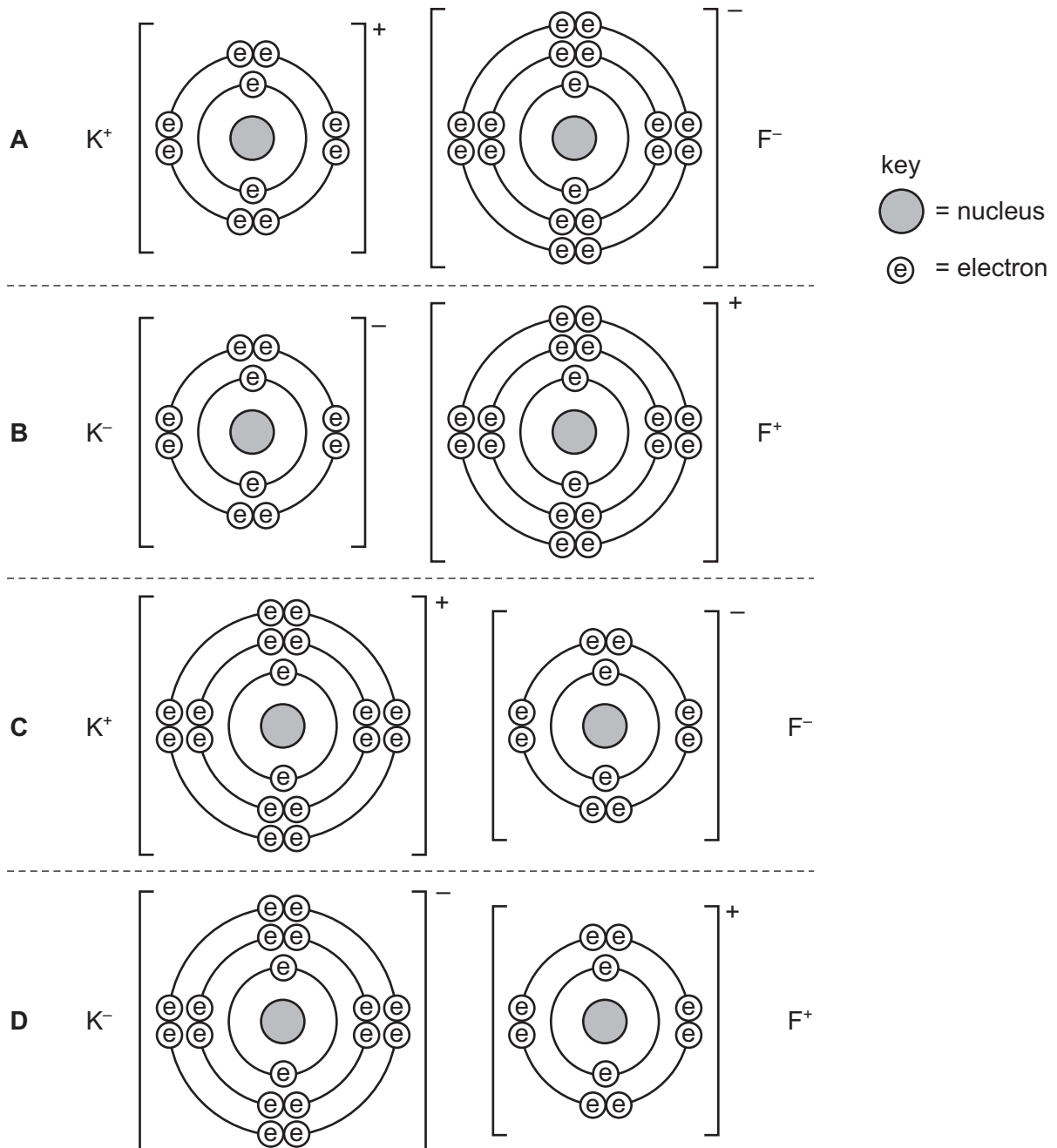

5 What do the nuclei of ${}^1_1\text{H}$ hydrogen atoms contain?

- A electrons and neutrons
- B electrons and protons
- C neutrons only
- D protons only

6 The electronic structures of atoms X and Y are shown.

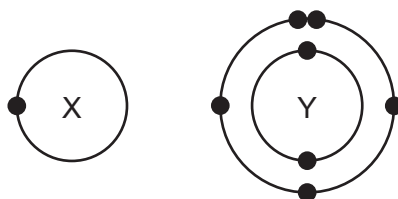

X and Y form a covalent compound.

What is its formula?

- A XY_5
- B XY_3
- C XY
- D X_3Y

7 Two atoms of magnesium, Mg, react with one molecule of oxygen, O_2 .

What is the formula of the product?

- A MgO
- B MgO_2
- C Mg_2O
- D Mg_2O_2

8 Which row describes the electrolysis of molten potassium bromide?

	product at anode	product at cathode
A	bromine	hydrogen
B	bromine	potassium
C	hydrogen	bromine
D	potassium	bromine

9 The diagram shows a section of an overhead power cable.

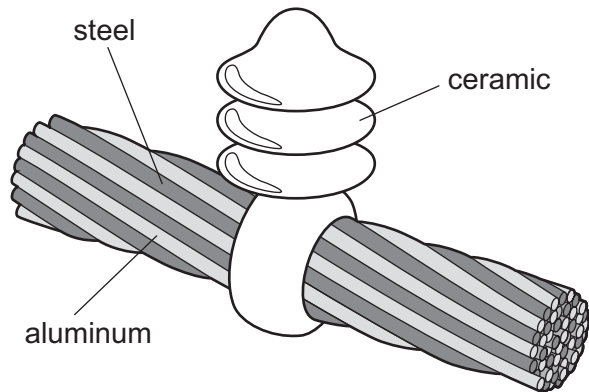

Which statement explains why a particular substance is used?

- A Aluminum has a low density and is a good conductor of electricity.
 - B Ceramic is a good conductor of electricity.
 - C Steel can rust in damp air.
 - D Steel is more dense than aluminum.
- 10 Which reaction is endothermic?
- A acid neutralizing alkali causing a temperature increase
 - B adding magnesium to hydrochloric acid
 - C calcium carbonate decomposing when heated
 - D combustion of fossil fuels

11 Solid hydrated sodium carbonate was added to solid citric acid.

The mixture was stirred and the temperature recorded every 10 seconds.

The results are shown on the graph:

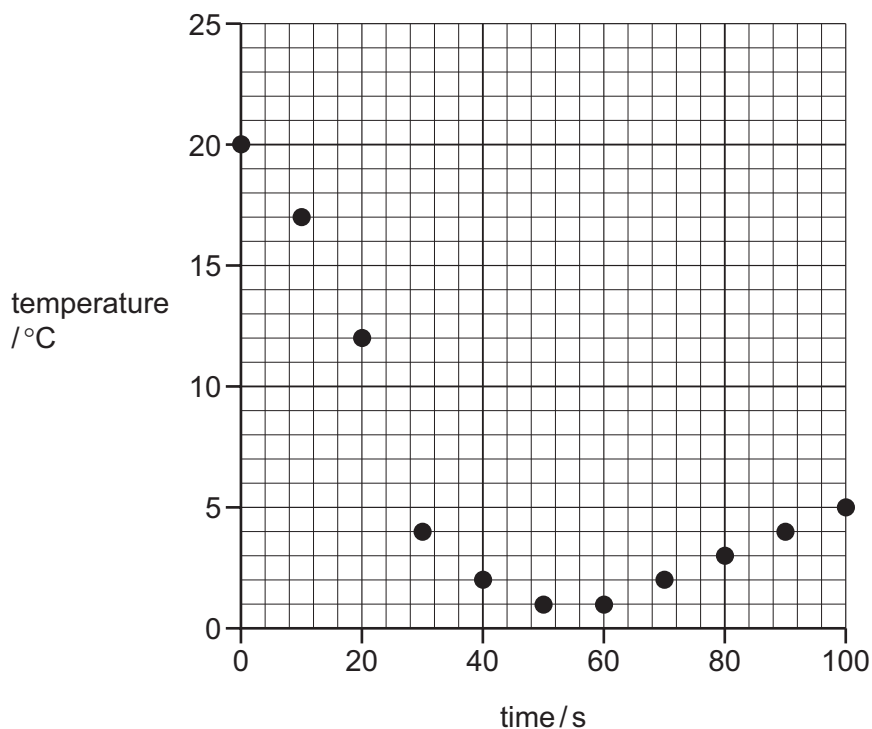

Which row describes the reaction?

	reaction type	energy change
A	neutralization	endothermic
B	neutralization	exothermic
C	thermal decomposition	endothermic
D	thermal decomposition	exothermic

12 The effect of temperature on the rate of the reaction between marble chips and hydrochloric acid can be investigated by measuring the production of carbon dioxide.

Which item of equipment is **not** required for the investigation?

- A** condenser
- B** gas syringe
- C** stopwatch
- D** thermometer

13 The element vanadium, V, forms several oxides.

In which change is oxidation taking place?

- A** $\text{VO}_2 \rightarrow \text{V}_2\text{O}_3$
B $\text{V}_2\text{O}_5 \rightarrow \text{VO}_2$
C $\text{V}_2\text{O}_3 \rightarrow \text{VO}$
D $\text{V}_2\text{O}_3 \rightarrow \text{V}_2\text{O}_5$

14 Some crystals of hydrated cobalt(II) chloride are heated in a test-tube until no further change is observed.

The test-tube is allowed to cool and a few drops of water are then added to the contents.

Which colors are observed?

	before heating	after heating	after adding water
A	blue	pink	blue
B	blue	white	blue
C	pink	blue	pink
D	white	blue	white

15 The diagram shows a simplified form of the Periodic Table:

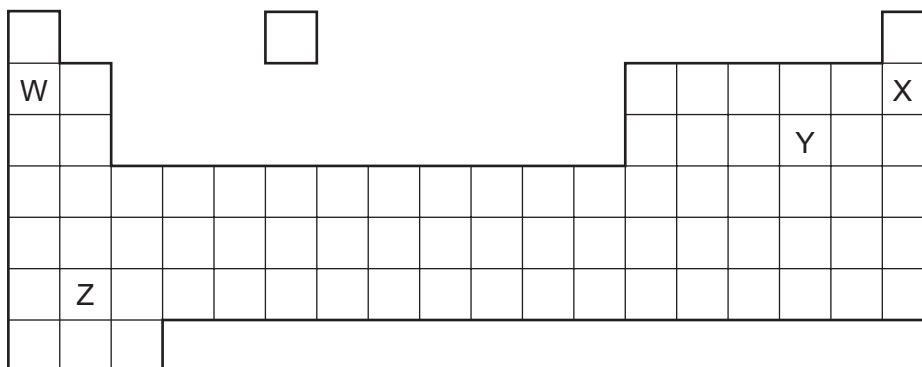

Which elements will form an acidic oxide?

- A** W and Z **B** W only **C** X and Y only **D** Y only

16 A white solid is insoluble in water.

When it is added to hydrochloric acid, bubbles of gas are formed.

Adding aqueous ammonia to the solution formed gives a white precipitate. Adding excess aqueous ammonia causes the precipitate to re-dissolve.

What is the white solid?

- A aluminum nitrate
- B ammonium nitrate
- C calcium carbonate
- D zinc carbonate

17 Which property is **not** characteristic of a base?

- A It reacts with a carbonate to form carbon dioxide.
- B It reacts with an acid to form a salt.
- C It reacts with an ammonium salt to form ammonia.
- D It turns universal indicator paper blue.

18 Four stages in the preparation of a salt from an acid and a solid metal oxide are listed.

- 1 Add excess solid.
- 2 Evaporate half the solution and leave to cool.
- 3 Filter to remove unwanted solid.
- 4 Heat the acid.

In which order should the stages be carried out?

- A 1 → 3 → 4 → 2
- B 2 → 1 → 3 → 4
- C 4 → 1 → 3 → 2
- D 4 → 2 → 1 → 3

19 Which statements about Group I and Group VII elements are correct?

- 1 In Group I, lithium is more reactive than potassium.
- 2 In Group VII, chlorine is more reactive than fluorine.

	statement 1	statement 2
A	✓	✓
B	✓	x
C	x	✓
D	x	x

20 The Periodic Table lists all the known elements.

Elements are arranged in order of 1 number.

The melting points of Group I elements 2 down the group.

The melting points of Group VII elements 3 down the group.

Which words correctly complete the gaps 1, 2 and 3?

	1	2	3
A	nucleon	decrease	increase
B	nucleon	increase	decrease
C	proton	decrease	increase
D	proton	increase	decrease

21 The table gives information about four elements.

Which element is a transition metal?

	electrical conductivity	density in g/cm ³	melting point in °C
A	good	0.97	98
B	good	7.86	1535
C	poor	2.33	1410
D	poor	3.12	-7

22 The Group 0 elements are unreactive.

The gas used to fill balloons is X..... .

This gas is unreactive because it has Y..... electrons in its outermost shell.

Which words correctly complete gaps X and Y?

	X	Y
A	argon	eight
B	argon	two
C	helium	eight
D	helium	two

23 Which diagram shows the structure of an alloy?

A

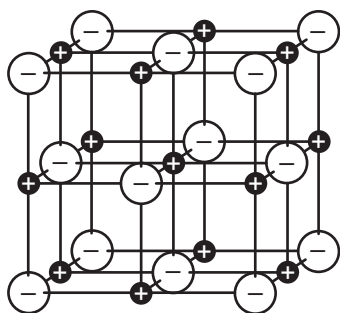

B

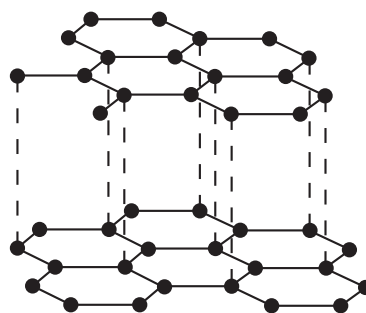

C

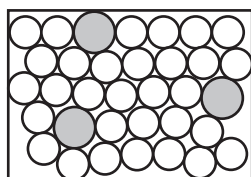

D

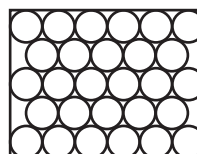

24 The diagrams show what happens when three different metals are added to water.

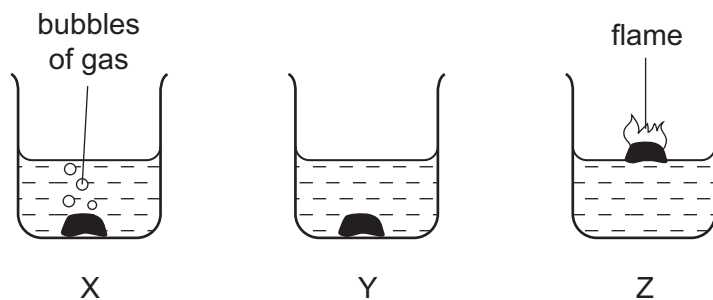

What are X, Y and Z?

	X	Y	Z
A	calcium	copper	potassium
B	copper	calcium	potassium
C	potassium	calcium	copper
D	potassium	copper	calcium

25 Which metal would be suitable for all of the following uses?

- making aircraft bodies
- making food containers
- making overhead power cables

- A aluminum
- B brass
- C mild steel
- D pure iron

26 Iron is extracted from its ore (hematite) in the blast furnace.

Which gas is produced as a waste product?

- A carbon dioxide
- B hydrogen
- C nitrogen
- D oxygen

27 Which statements about water are correct?

- 1 Household water may contain salts in solution.
- 2 Water for household use is filtered to remove soluble impurities.
- 3 Water is treated with chlorine to kill bacteria.
- 4 Water is used in industry for cooling.

- A** 1, 2, 3 and 4
B 1, 2 and 3 only
C 1, 3 and 4 only
D 2, 3 and 4 only

28 Which is a use of oxygen?

- A** as the gas in a lamp
B to react with ethene to form ethanol
C to react with methane in a Bunsen burner
D to react with hematite to form iron

29 Carbon monoxide is an air pollutant produced when petrol is burned in a car engine.

Why is carbon monoxide considered to be an air pollutant?

- A** It causes climate change.
B It causes the corrosion of buildings.
C It is a significant greenhouse gas.
D It is poisonous.

30 Fertilizers are mixtures of different compounds used to increase the growth of crops.

Which pair of substances contains the three essential elements for plant growth?

- A** ammonium nitrate and calcium phosphate
B ammonium nitrate and potassium chloride
C ammonium phosphate and potassium chloride
D potassium nitrate and calcium carbonate

31 Which process does **not** produce carbon dioxide?

- A complete combustion of a fossil fuel
- B fermentation
- C reaction of an alkali with a carbonate
- D respiration

32 The apparatus shown is set up and left for a week.

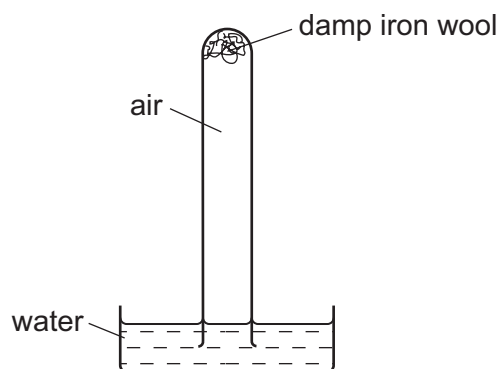

Which diagram shows the level of the water at the end of the week?

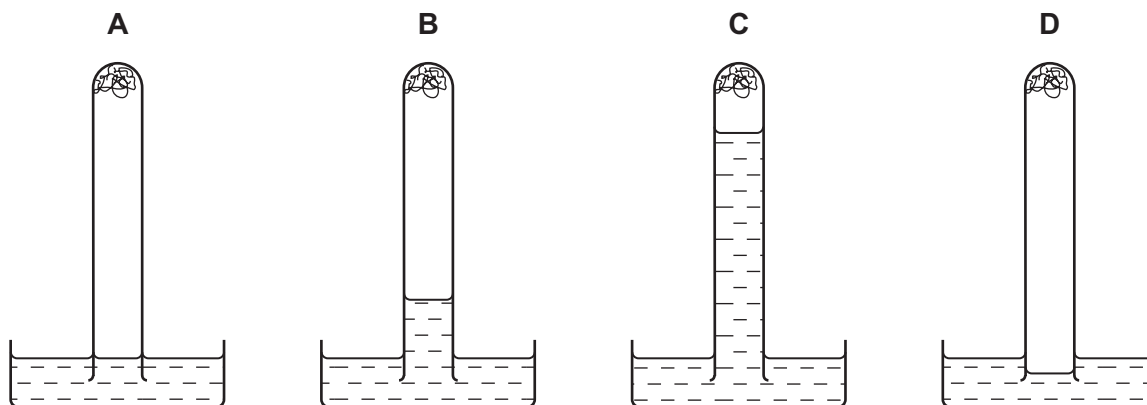

33 Carbon dioxide and methane both contribute to climate change.

Which process produces both gases?

- A complete combustion of natural gas
- B farming cattle
- C heating calcium carbonate
- D respiration

34 A student is asked to draw a diagram showing the uses of limestone.

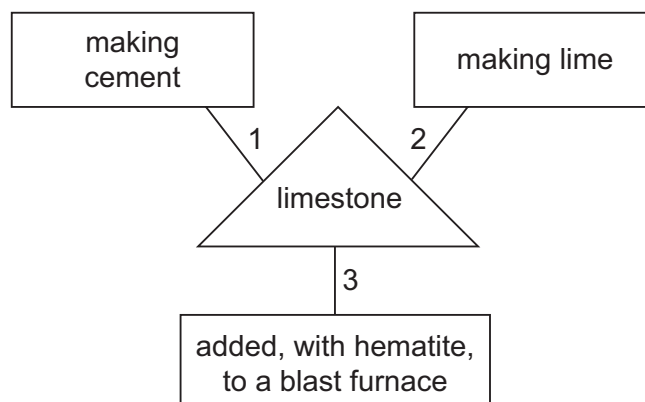

Which numbered lines show a correct use of limestone?

- A 1, 2 and 3
- B 1 and 2 only
- C 1 and 3 only
- D 2 and 3 only

35 The diagram shows the structure of a simple hydrocarbon and the products of two of its reactions.

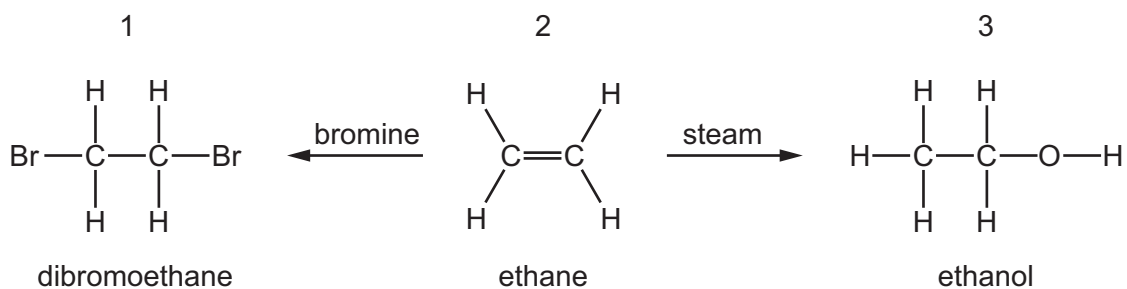

Which structures are named correctly?

	structure		
	1	2	3
A	✓	✓	x
B	✓	x	✓
C	x	✓	✓
D	x	✓	x

36 Which row describes the formation of a polymer?

	monomer	polymer
A	ethane	poly(ethane)
B	ethane	poly(ethene)
C	ethene	poly(ethane)
D	ethene	poly(ethene)

37 What is **not** the correct use for the fraction named?

	name of fraction	use
A	fuel oil	making waxes
B	gas oil	diesel engines
C	kerosene	jet fuel
D	naphtha fraction	making chemicals

38 Ethanol can be formed by

- 1 fermentation
- 2 reaction between steam and ethene

Which of these processes uses a catalyst?

	1	2
A	✓	✓
B	✓	x
C	x	✓
D	x	x

39 Which homologous series is **not** represented in the compounds shown below?

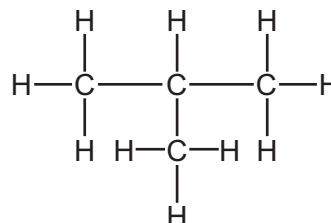
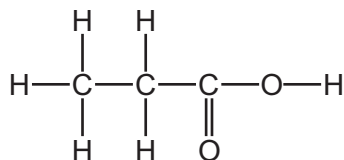
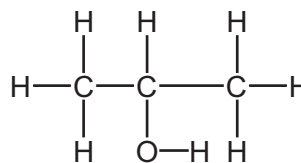
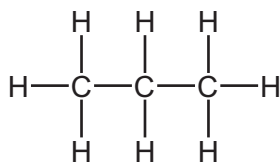

- A alcohols
- B alkanes
- C alkenes
- D carboxylic acids

40 Alkenes are manufactured by cracking hydrocarbons obtained from petroleum.

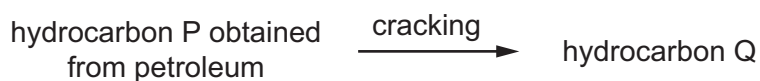

Which row describes the size of the molecules in hydrocarbons P and Q and the effect of Q on aqueous bromine?

	size of P molecules	size of Q molecules	effect of Q on aqueous bromine
A	large	small	decolorizes
B	large	small	no effect
C	small	large	decolorizes
D	small	large	no effect

