

CANDIDATE  
NAME

CENTRE  
NUMBER

--	--	--	--	--

CANDIDATE  
NUMBER

--	--	--	--

**MATHEMATICS**

**0581/43**

Paper 4 (Extended)

**October/November 2014**

**2 hours 30 minutes**

Candidates answer on the Question Paper.

Additional Materials:      Electronic calculator  
   Tracing paper (optional)

Geometrical instruments

**READ THESE INSTRUCTIONS FIRST**

Write your Centre number, candidate number and name on all the work you hand in.

Write in dark blue or black pen.

You may use an HB pencil for any diagrams or graphs.

Do not use staples, paper clips, glue or correction fluid.

**DO NOT WRITE IN ANY BARCODES.**

Answer **all** questions.

If working is needed for any question it must be shown below that question.

Electronic calculators should be used.

If the degree of accuracy is not specified in the question, and if the answer is not exact, give the answer to three significant figures. Give answers in degrees to one decimal place.

For  $\pi$ , use either your calculator value or 3.142.

At the end of the examination, fasten all your work securely together.

The number of marks is given in brackets [ ] at the end of each question or part question.

The total of the marks for this paper is 130.

This document consists of **16** printed pages.



- 1 (a)  $ABCD$  is a trapezium.

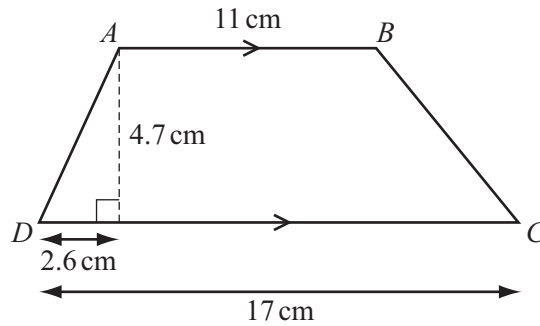

NOT TO  
SCALE

- (i) Calculate the length of  $AD$ .

Answer(a)(i)  $AD = \dots\dots\dots$  cm [2]

- (ii) Calculate the size of angle  $BCD$ .

Answer(a)(ii) Angle  $BCD = \dots\dots\dots$  [3]

- (iii) Calculate the area of the trapezium  $ABCD$ .

Answer(a)(iii)  $\dots\dots\dots$   $\text{cm}^2$  [2]

- (b) A **similar** trapezium has perpendicular height 9.4 cm.

Calculate the area of this trapezium.

Answer(b)  $\dots\dots\dots$   $\text{cm}^2$  [3]

- 2 There are three different areas, A, B and C, for seating in a theatre.  
The numbers of seats in each area are in the ratio  $A : B : C = 11 : 8 : 7$ .  
There are 920 seats in area B.

- (a) (i) Show that there are 805 seats in area C.

*Answer(a)(i)*

[1]

- (ii) Write the number of seats in area B as a percentage of the total number of seats.

*Answer(a)(ii)* ..... % [2]

- (b) The cost of a ticket for a seat in each area of the theatre is shown in the table.

Area A	\$11.50
Area B	\$15
Area C	\$22.50

For a concert 80% of area B tickets were sold and  $\frac{3}{5}$  of area C tickets were sold.  
The total amount of money taken from ticket sales was \$35 834.

Calculate the number of area A tickets that were sold.

*Answer(b)* ..... [5]

- (c) The total ticket sales of \$35 834 was 5% less than the ticket sales at the previous concert.

Calculate the ticket sales at the previous concert.

*Answer(c)* \$..... [3]

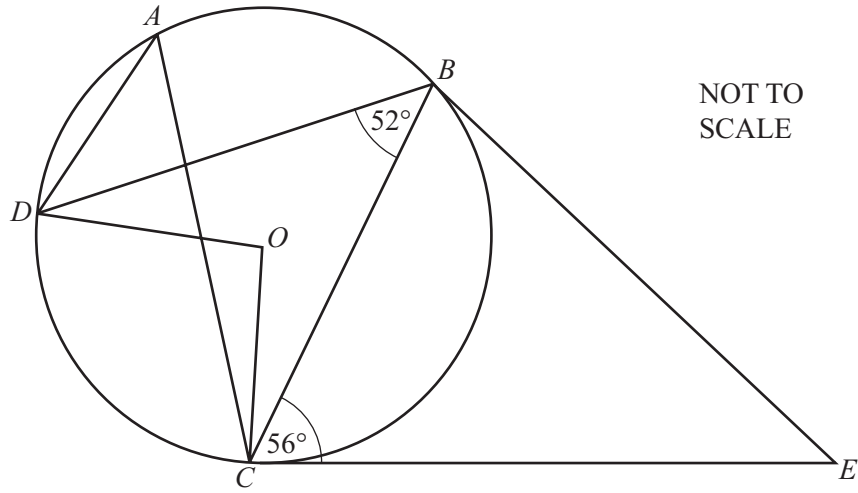

NOT TO SCALE

$A, B, C$  and  $D$  are points on a circle, centre  $O$ .  
 $CE$  is a tangent to the circle at  $C$ .

(a) Find the sizes of the following angles and give a reason for each answer.

(i) Angle  $DAC = \dots\dots\dots$  because  $\dots\dots\dots$   
 $\dots\dots\dots$  [2]

(ii) Angle  $DOC = \dots\dots\dots$  because  $\dots\dots\dots$   
 $\dots\dots\dots$  [2]

(iii) Angle  $BCO = \dots\dots\dots$  because  $\dots\dots\dots$   
 $\dots\dots\dots$  [2]

(b)  $CE = 8.9$  cm and  $CB = 7$  cm.

(i) Calculate the length of  $BE$ .

*Answer(b)(i)*  $BE = \dots\dots\dots$  cm [4]

(ii) Calculate angle  $BEC$ .

*Answer(b)(ii)* Angle  $BEC = \dots\dots\dots$  [3]

---

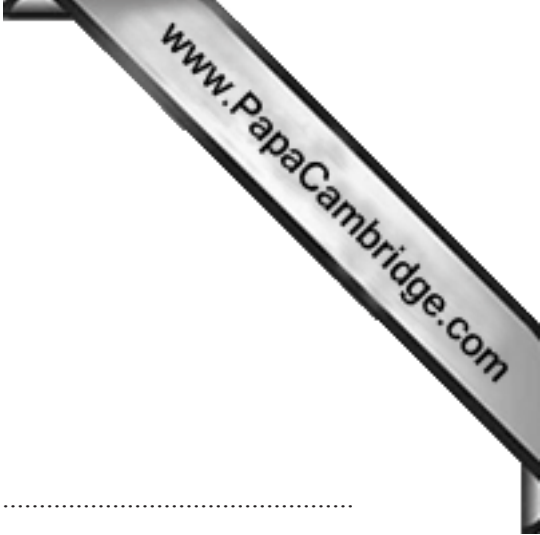

4 Yeung and Ariven compete in a triathlon race.  
The probability that Yeung finishes this race is  $\frac{3}{5}$ .  
The probability that Ariven finishes this race is  $\frac{2}{3}$ .

- (a) (i) Which of them is more likely to finish this race?  
Give a reason for your answer.

*Answer(a)(i)* ..... because .....  
..... [1]

- (ii) Find the probability that they both finish this race.

*Answer(a)(ii)* ..... [2]

- (iii) Find the probability that only one of them finishes this race.

*Answer(a)(iii)* ..... [3]

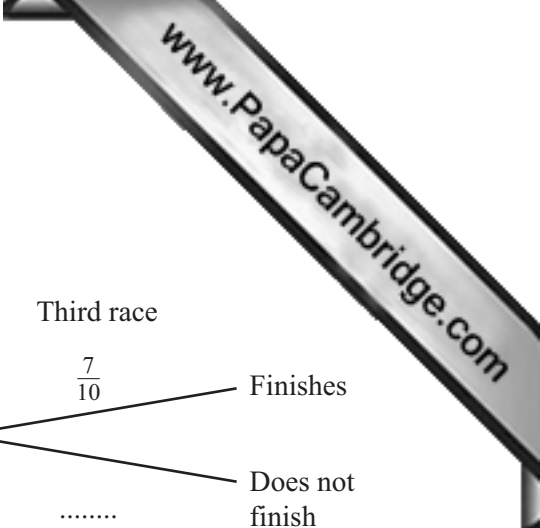

(b) After the first race, **Yeung** competes in two further triathlon races.

(i) Complete the tree diagram.

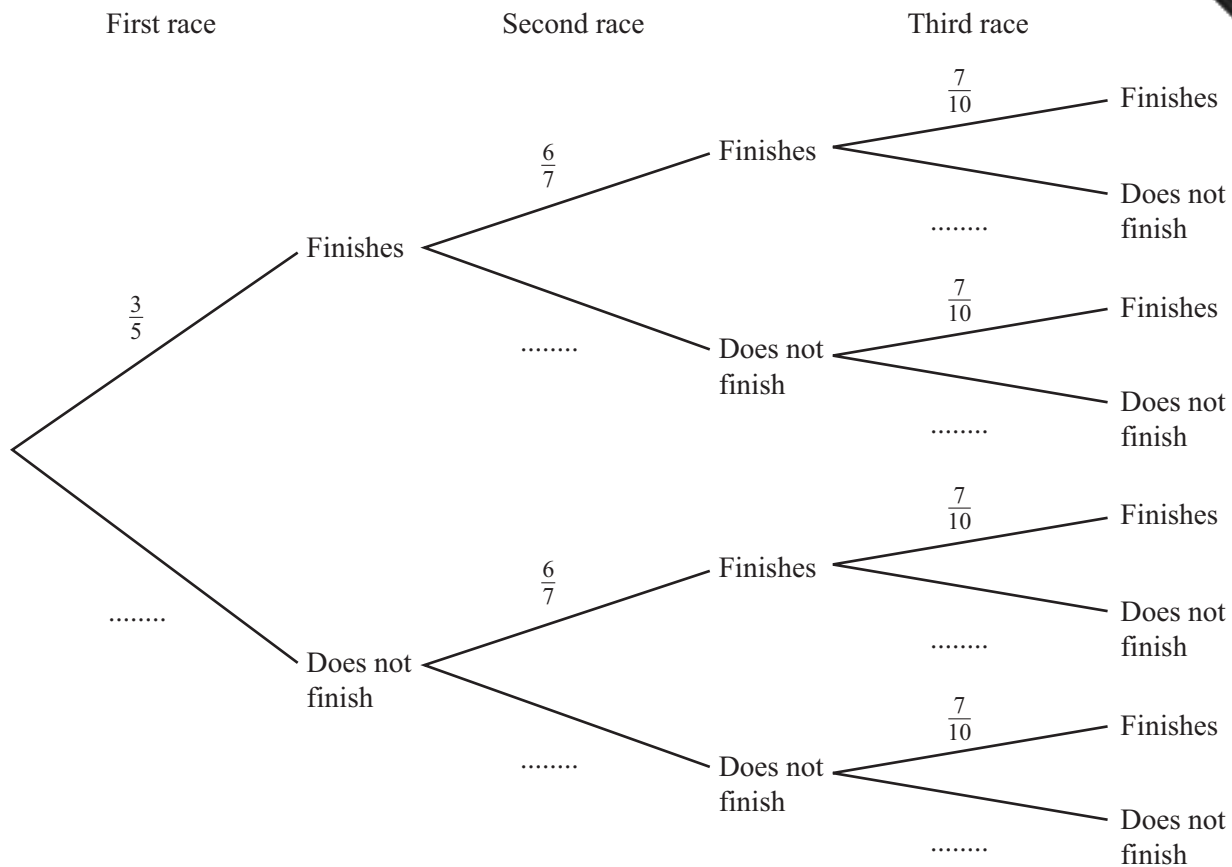

[3]

(ii) Calculate the probability that Yeung finishes all three of his races.

Answer(b)(ii) ..... [2]

(iii) Calculate the probability that Yeung finishes at least one of his races.

Answer(b)(iii) ..... [3]

$$5 \quad \mathbf{P} = \begin{pmatrix} 0 & -1 \\ 1 & 0 \end{pmatrix} \quad \mathbf{Q} = \begin{pmatrix} 1 & -2 \\ 0 & 1 \end{pmatrix} \quad \mathbf{R} = \begin{pmatrix} -3 \\ 5 \end{pmatrix}$$

(a) Work out

(i)  $4\mathbf{P}$ ,

*Answer(a)(i)*

[1]

(ii)  $\mathbf{P} - \mathbf{Q}$ ,

*Answer(a)(ii)*

[1]

(iii)  $\mathbf{P}^2$ ,

*Answer(a)(iii)*

[2]

(iv)  $\mathbf{QR}$ .

*Answer(a)(iv)*

[2]

(b) Find the matrix  $\mathbf{S}$ , so that  $\mathbf{QS} = \begin{pmatrix} 1 & 0 \\ 0 & 1 \end{pmatrix}$ .

*Answer(b)*

[3]



6 (a) Simplify.

(i)  $x^3 \div \frac{3}{x^5}$

Answer(a)(i) ..... [1]

(ii)  $5xy^8 \times 3x^6y^{-5}$

Answer(a)(ii) ..... [2]

(iii)  $(64x^{12})^{\frac{2}{3}}$

Answer(a)(iii) ..... [2]

(b) Solve  $3x^2 - 7x - 12 = 0$ .

Show your working and give your answers correct to 2 decimal places.

Answer(b)  $x = \dots\dots\dots$  or  $x = \dots\dots\dots$  [4]

(c) Simplify  $\frac{x^2 - 25}{x^3 - 5x^2}$ .

Answer(c) ..... [3]

7

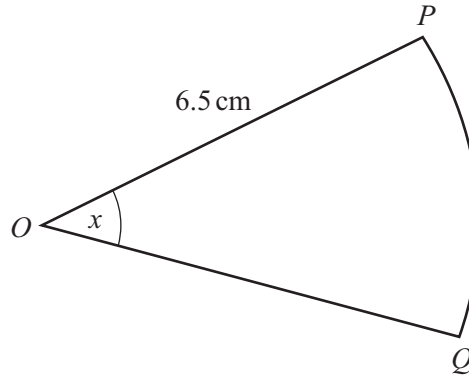
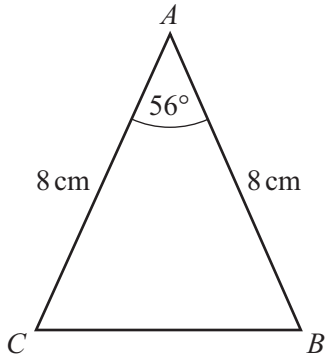

NOT TO SCALE

The diagram shows a triangle and a sector of a circle.  
In triangle  $ABC$ ,  $AB = AC = 8$  cm and angle  $BAC = 56^\circ$ .  
Sector  $OPQ$  has centre  $O$ , sector angle  $x$  and radius  $6.5$  cm.

(a) Show that the area of triangle  $ABC$  is  $26.5$  cm<sup>2</sup> correct to 1 decimal place.

*Answer(a)*

[2]

(b) The area of sector  $OPQ$  is equal to the area of triangle  $ABC$ .

(i) Calculate the sector angle  $x$ .

*Answer(b)(i)* ..... [3]

(ii) Calculate the perimeter of the sector  $OPQ$ .

*Answer(b)(ii)* ..... cm [3]

- (c) The diagram shows a sector of a circle, radius  $r$  cm.

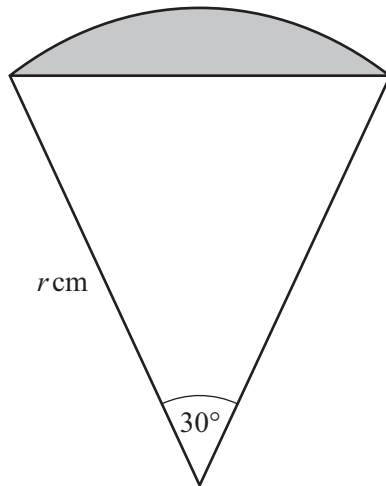

NOT TO  
SCALE

- (i) Show that the area of the shaded segment is  $\frac{1}{4}r^2\left(\frac{1}{3}\pi - 1\right)$  cm<sup>2</sup>.

*Answer(c)(i)*

[4]

- (ii) The area of the segment is 5 cm<sup>2</sup>.

Find the value of  $r$ .

*Answer(c)(ii)*  $r = \dots\dots\dots$  [3]

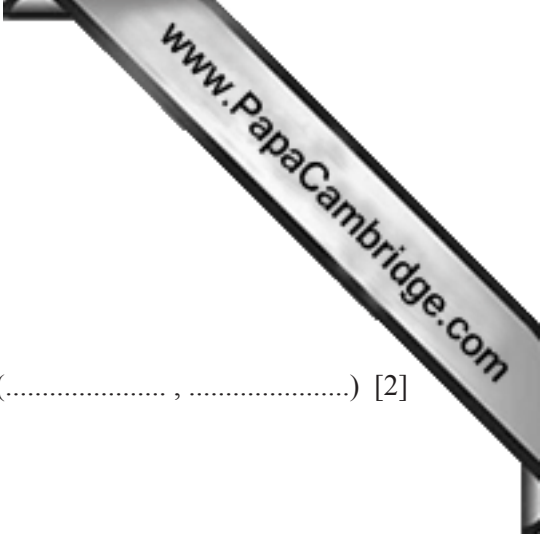

8 (a) A straight line joins the points  $(-1, -4)$  and  $(3, 8)$ .

(i) Find the midpoint of this line.

Answer(a)(i) (....., .....) [2]

(ii) Find the equation of this line.  
Give your answer in the form  $y = mx + c$ .

Answer(a)(ii)  $y =$  ..... [3]

(b) (i) Factorise  $x^2 + 3x - 10$ .

Answer(b)(i) ..... [2]

(ii) The graph of  $y = x^2 + 3x - 10$  is sketched below.

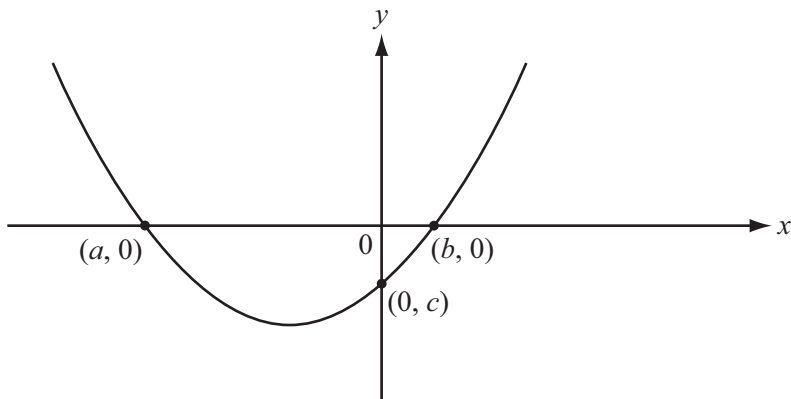

NOT TO SCALE

Write down the values of  $a$ ,  $b$  and  $c$ .

Answer(b)(ii)  $a =$  .....

$b =$  .....

$c =$  ..... [3]

(iii) Write down the equation of the line of symmetry of the graph of  $y = x^2 + 3x - 10$ .

Answer(b)(iii) ..... [1]

- (c) Sketch the graph of  $y = 18 + 7x - x^2$  on the axes below.  
Indicate clearly the values where the graph crosses the  $x$  and  $y$  axes.

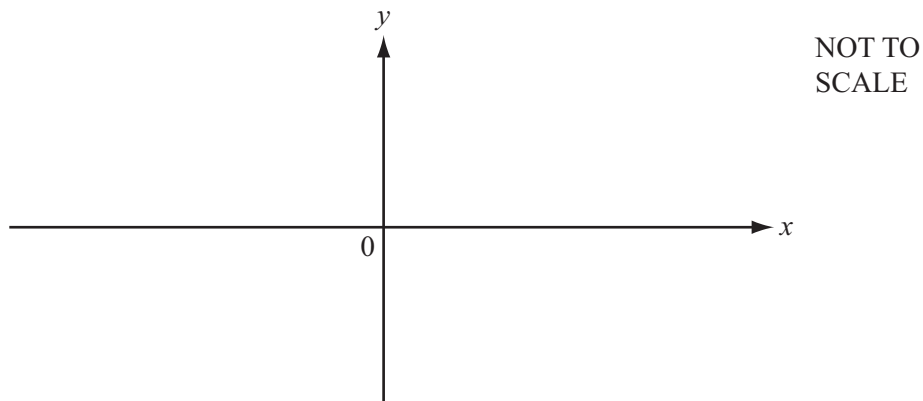

[4]

(d) (i)  $x^2 + 12x - 7 = (x + p)^2 - q$

Find the value of  $p$  and the value of  $q$ .

*Answer(d)(i)*  $p = \dots\dots\dots$

$q = \dots\dots\dots$  [3]

- (ii) Write down the minimum value of  $y$  for the graph of  $y = x^2 + 12x - 7$ .

*Answer(d)(ii)*  $\dots\dots\dots$  [1]

- 9 (a) Ricardo asks some motorists how many litres of fuel they use in one day. The numbers of litres, correct to the nearest litre, are shown in the table.

Number of litres	16	17	18	19	20
Number of motorists	11	10	$p$	4	8

- (i) For this table, the mean number of litres is 17.7 .

Calculate the value of  $p$ .

Answer(a)(i)  $p = \dots\dots\dots$  [4]

- (ii) Find the median number of litres.

Answer(a)(ii)  $\dots\dots\dots$  litres [1]

- (b) Manuel completed a journey of 320 km in his car. The fuel for the journey cost \$1.28 for every 6.4 km travelled.

- (i) Calculate the cost of fuel for this journey.

Answer(b)(i) \$  $\dots\dots\dots$  [2]

- (ii) When Manuel travelled 480 km in his car it used 60 litres of fuel. Manuel’s car used fuel at the same rate for the journey of 320 km.

Calculate the number of litres of fuel the car used for the journey of 320 km.

Answer(b)(ii)  $\dots\dots\dots$  litres [2]

- (iii) Calculate the cost per litre of fuel used for the journey of 320 km.

Answer(b)(iii) \$  $\dots\dots\dots$  [2]

- (c) Ellie drives a car at a constant speed of 30 m/s correct to the nearest 5 m/s. She maintains this speed for 5 minutes correct to the nearest 10 seconds.

Calculate the upper bound of the distance in **kilometres** that Ellie could have travelled.

*Answer(c)* ..... km [5]

10 (a)

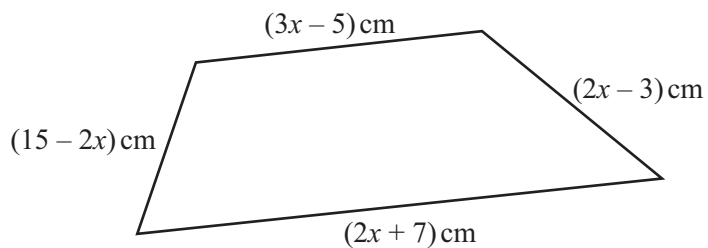

NOT TO  
SCALE

- (i) Write an expression, in terms of  $x$ , for the perimeter of the quadrilateral. Give your answer in its simplest form.

*Answer(a)(i)* ..... cm [2]

- (ii) The perimeter of the quadrilateral is 32 cm.

Find the length of the longest side of the quadrilateral.

*Answer(a)(ii)* ..... cm [3]

**Question 10(b) is printed on the next page.**

(b)

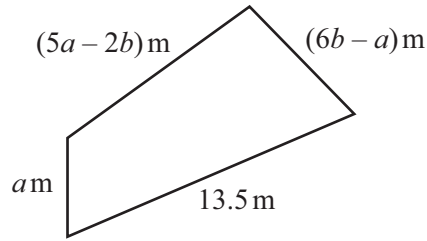
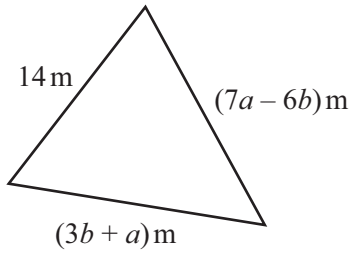

NOT TO SCALE

The triangle has a perimeter of  $32.5\text{ m}$ .  
The quadrilateral has a perimeter of  $39.75\text{ m}$ .

Write two equations in terms of  $a$  and  $b$  and simplify them.  
Use an algebraic method to find the values of  $a$  and  $b$ .  
Show all your working.

Answer(b)  $a = \dots\dots\dots$

$b = \dots\dots\dots$  [6]

Permission to reproduce items where third-party owned material protected by copyright is included has been sought and cleared where possible. Every reasonable effort has been made by the publisher (UCLES) to trace copyright holders, but if any items requiring clearance have unwittingly been included the publisher will be pleased to make amends at the earliest possible opportunity.

Cambridge International Examinations is part of the Cambridge Assessment Group. Cambridge Assessment is the brand name of University of Cambridge Local Examinations Syndicate (UCLES), which is itself a department of the University of Cambridge.