



UNIVERSITY OF CAMBRIDGE INTERNATIONAL EXAMINATIONS  
International General Certificate of Secondary Education

CANDIDATE NAME

CENTRE NUMBER

CANDIDATE NUMBER

\* 7 5 3 1 2 1 6 2 7 1 \*

**COMBINED SCIENCE**

**0653/61**

Paper 6 Alternative to Practical

**October/November 2012**

**1 hour**

Candidates answer on the Question paper

No Additional Materials are required.

**READ THESE INSTRUCTIONS FIRST**

Write your Centre number, candidate number and name on all the work you hand in.

Write in dark blue or black pen.

You may use a soft pencil for any diagrams, graphs, tables or rough working.

Do not use staples, paper clips, highlighters, glue or correction fluid.

**DO NOT WRITE IN ANY BARCODES.**

Answer **all** questions.

At the end of the examination, fasten all your work securely together.

The number of marks is given in brackets [ ] at the end of each question or part question.

For Examiner's Use	
1	
2	
3	
4	
5	
6	
<b>Total</b>	

This document consists of **22** printed pages and **2** blank pages.



- 1 In an experiment to investigate some of the conditions needed for seed germination, four petri dishes were set up as shown in Fig. 1.1.

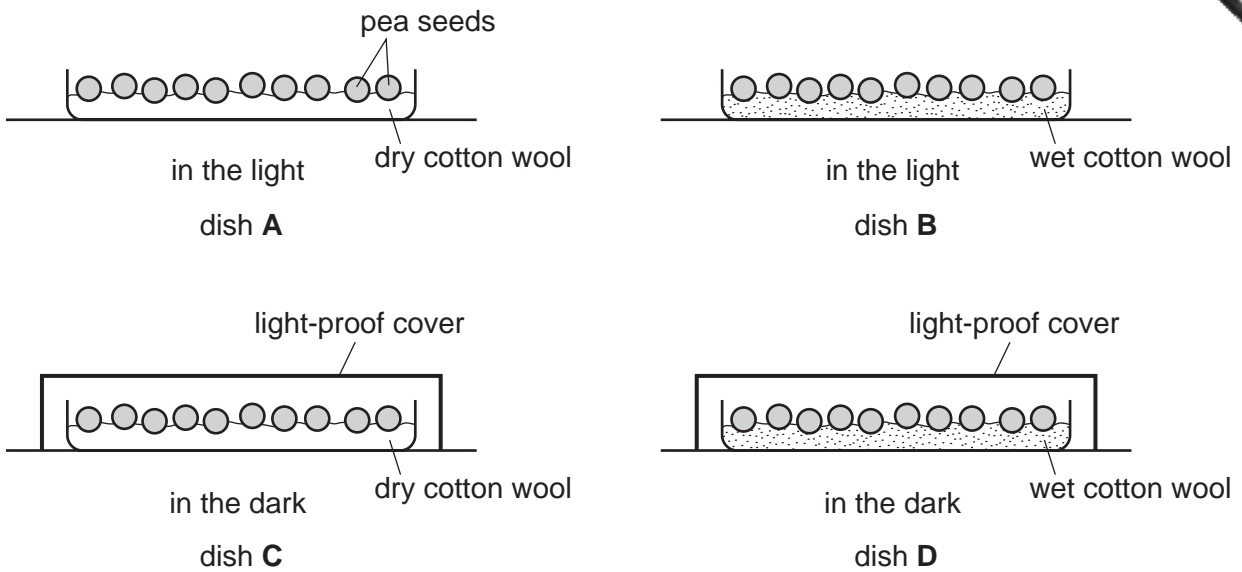

**Fig. 1.1**

Each petri dish contains some pea seeds. The seeds were soaked in water for 24 hours before being placed in the dishes.

The four petri dishes were treated as follows:

- Dish **A** was left in the light, with the seeds on dry cotton wool.
- Dish **B** was left in the light, with the seeds on wet cotton wool.
- Dish **C** was left in the dark, with the seeds on dry cotton wool.
- Dish **D** was left in the dark, with the seeds on wet cotton wool.

The dishes were then left for 10 days.

After 10 days, when the covers were removed, the results were as shown in Fig. 1.2.

3

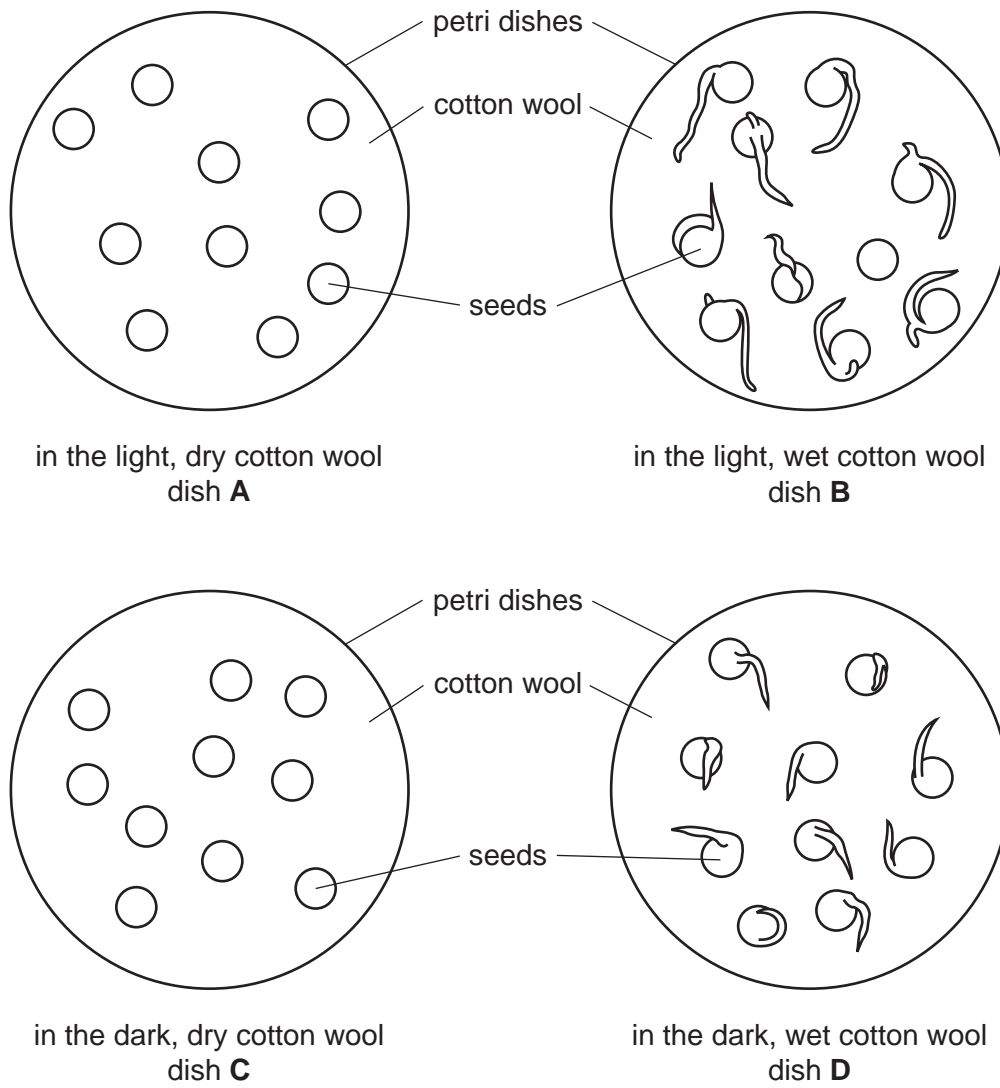

**Fig. 1.2**

- (a) Examine Fig. 1.2, and make a note of
- (i) the total number of seeds in each dish,
  - (ii) the number of seeds that have begun to germinate as indicated by the clear emergence of a radicle (young root) from any seed.

Record these numbers in Table 1.1.

**Table 1.1**

petri dish	A	B	C	D
total number of seeds in the dish				
number of germinating seeds in the dish				

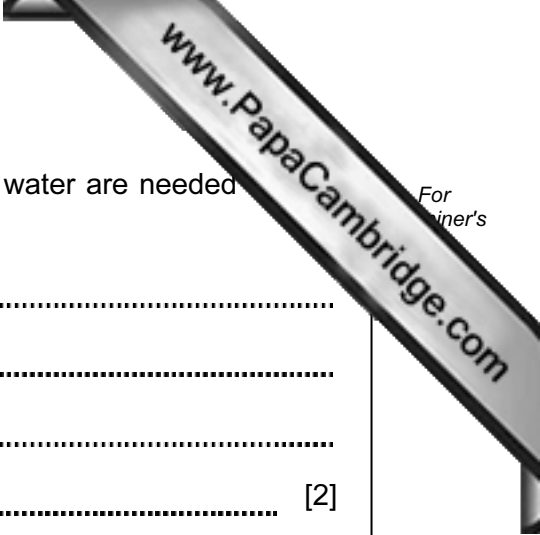

(b) Use the results to write conclusions about whether light and water are needed for germination of pea seeds.

light .....

.....

water .....

..... [2]

(c) Explain why several seeds were placed in each dish, rather than just one seed.

.....

.....

..... [1]

(d) Suggest **two** other environmental conditions, apart from light and water, that could be important for the germination of pea seeds.

.....

..... [2]

- (e) In a further experiment, the germinating seeds were tested for the presence of starch and reducing sugar. The radicles (roots) were cut off from the main part of the seedling and the radicles and the seeds were tested separately. The results were as shown in Table 1.2.

**Table 1.2**

part of the seedling	radicle	seed
colour obtained with Benedict's test	orange	blue
colour obtained with iodine test	orange-brown	blue-black

State which parts of the germinating seeds contained starch, and which contained reducing sugar.

starch .....

.....

reducing sugar .....

..... [2]

- (f) Name an enzyme that could convert starch to sugar in a germinating seed.

..... [1]

- 2 A student is doing an experiment to find the mass of a metre rule. He rests the rule on a pivot at the 40 cm mark.

He hangs a 100 g load at the 10 cm mark of the ruler. He hangs a balancing mass,  $m = 50$  g, on the other side of the rule so that the rule balances, see Fig. 2.1. The balancing mass is  $d$  cm from the pivot.

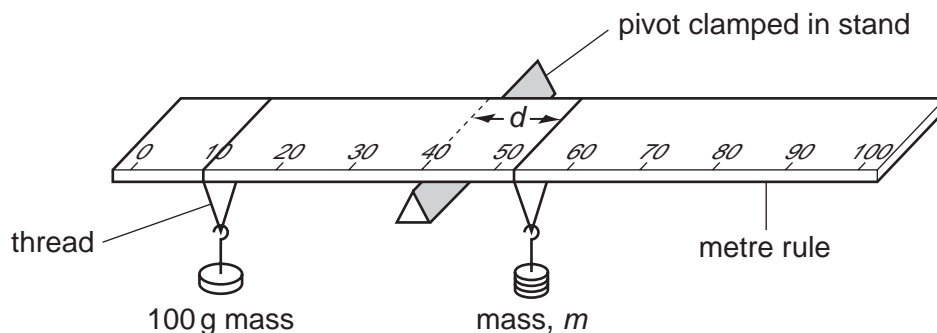

Fig. 2.1

- The student finds distance,  $d$ , and records it in Table 2.1.
- He adds 10 g to the balancing mass,  $m$ , and adjusts its position so that the rule balances.
- He finds the new distance,  $d$ , and records it in Table 2.1.
- He repeats this procedure using balancing masses,  $m$ , of 70, 80 and 90 g.

Table 2.1

mass, $m/g$	distance, $d/cm$	$\frac{1}{m} / \frac{1}{g}$
50	34.6	0.020
60	28.8	0.017
70		
80	21.9	0.013
90		

- (a) (i) Figs. 2.2 and 2.3 show the scale of the rule and the positions of the balance masses when  $m = 70\text{ g}$  and  $m = 90\text{ g}$ .

Read and record below the scale of the rule for each mass.

scale reading for 70 g mass = ..... cm

scale reading for 90 g mass = ..... cm

[2]

- (ii) Use your answers to (i) to calculate the values of  $d$  for each mass.

Record your values of  $d$  in Table 2.1.

[1]

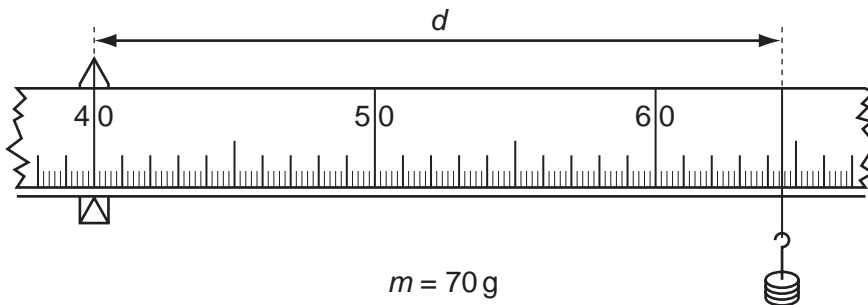

**Fig. 2.2**

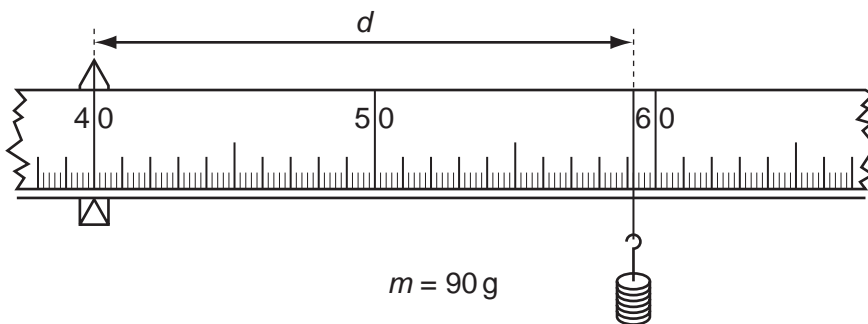

**Fig. 2.3**

- (iii) Calculate, to three decimal places, the values of  $\frac{1}{m}$  for the masses 70 g and 90 g.

Record these values in Table 2.1.

[2]

- (b) (i) On the graph grid provided, plot distance,  $d$ , (vertical axis) against  $\frac{1}{m}$ .

Draw the best straight line.

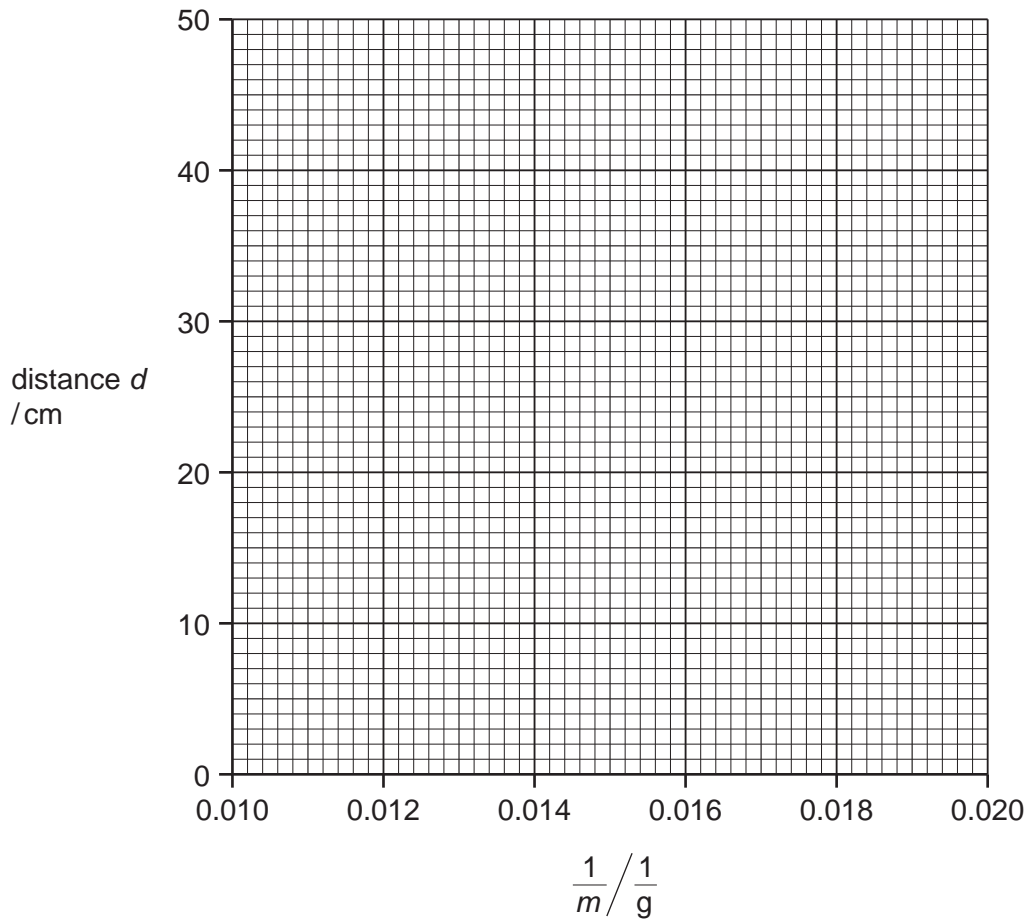

[2]

- (ii) Find the gradient of the straight line you have drawn. Show clearly on the graph how you obtain the values used to calculate the gradient.

gradient = ..... [2]



9

(c) Calculate the mass of the rule using the formula

$$\text{mass of rule} = 300 - \frac{\text{gradient}}{10}.$$

mass of the ruler = ..... g [1]

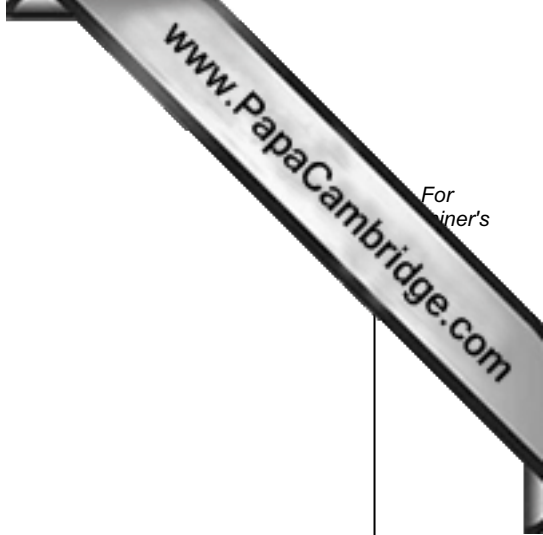

- 3 A farmer's bean crop is poor. He thinks that the soil in his field may be too acidic. He asks a science student three samples, **A**, **B** and **C** of the soil for testing.

There are two parts to the tests.

**Part 1**

The student takes some of sample **A** and mixes it with water. He separates the water from the soil by filtering the mixture. This gives soil washing **A**.

He repeats this procedure to give soil washings **B** and **C**.

- (a) Suggest **one** practical detail of this procedure that enables a fair comparison of the three soil samples.

.....

.....

..... [1]

**Part 2**

The student wants to find out what volume of soil washing **A** is needed to neutralise  $10\text{ cm}^3$  of aqueous calcium hydroxide solution. See Fig. 3.1.

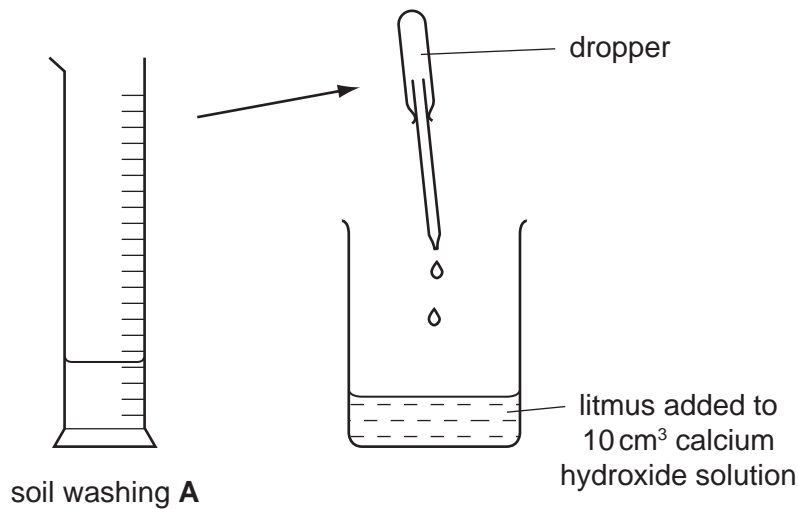

**Fig. 3.1**

- He places  $10\text{ cm}^3$  of calcium hydroxide solution in a beaker and adds a few drops of litmus.
- He places  $10\text{ cm}^3$  soil washing **A** in a measuring cylinder.
- He uses a dropper to add soil washing **A** from the measuring cylinder, drop by drop, to the calcium hydroxide in the beaker, until the litmus changes colour.
- He notes how much soil washing **A** is left in the measuring cylinder and records the volume in Table 3.1.
- He repeats this procedure with soil washings **B** and **C**.

(b) State the colour change of the litmus.

from ..... to .....

Fig. 3.2 shows the scales of the measuring cylinder containing soil washings **A**, **B** and **C** after the litmus has changed colour.

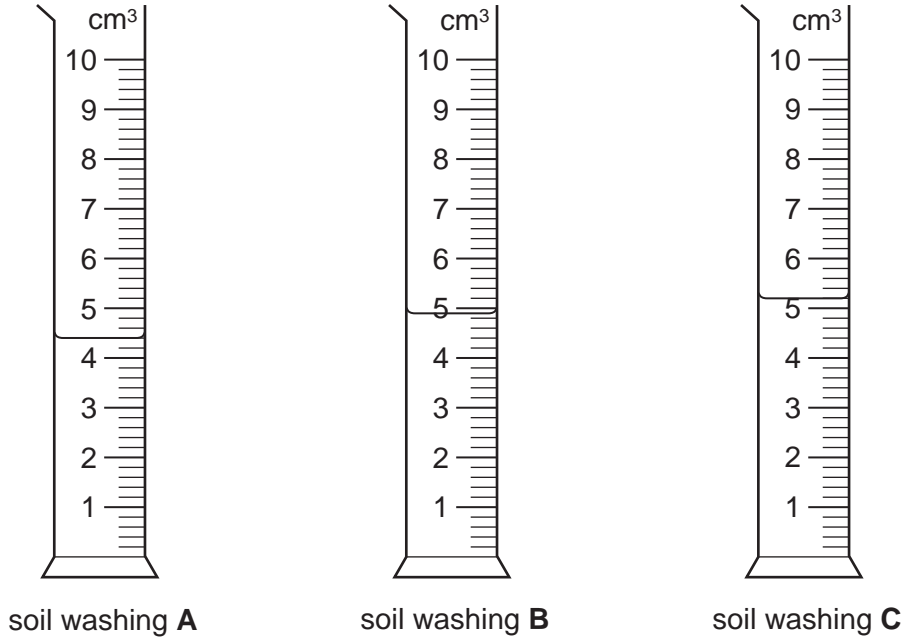

**Fig. 3.2**

(c) (i) Read the volumes left in the measuring cylinders and record them in Table 3.1. [3]

(ii) Calculate the volumes of soil washings **A**, **B** and **C** added to the calcium hydroxide solution. Record them in Table 3.1. [1]

**Table 3.1**

soil washing	volume left in measuring cylinder/cm <sup>3</sup>	volume of soil washings added/cm <sup>3</sup>
<b>A</b>		
<b>B</b>		
<b>C</b>		

Use data from the third column of Table 3.1 to calculate the average volume,  $V_{av}$ , of the soil washings added.

$V_{av} = \dots\dots\dots \text{cm}^3$  [1]

(d) The concentration of the calcium hydroxide solution is  $0.013 \text{ mol/dm}^3$ .

Using the equation given, calculate the concentration of the acid in the soil washings.

$$\text{concentration of acid} = \frac{(2 \times 0.013 \times 10)}{V_{\text{av}}}$$

concentration of acid = .....  $\text{mol/dm}^3$  [1]

The farmer can decide how much calcium hydroxide (lime) to put on his field.

If he adds too much lime so that the soil becomes alkaline, plants cannot absorb the ions of essential trace metals such as iron, magnesium and zinc because they become insoluble.

(e) Suggest why these ions become insoluble in alkaline soils.

.....  
..... [1]

- 4 A student used the apparatus shown in Fig. 4.1 to study the transpiration rate in a shoot.

As water vapour is transpired from the leaves, water is drawn through the apparatus. The rate of movement of the small bubble along the tube is used as an indication of the rate of transpiration.

The student wanted to find which surface of the leaves lost the greater amount of water vapour.

The student did two experiments, the first with the leaves untreated and a second with grease applied to the upper surface of the leaves.

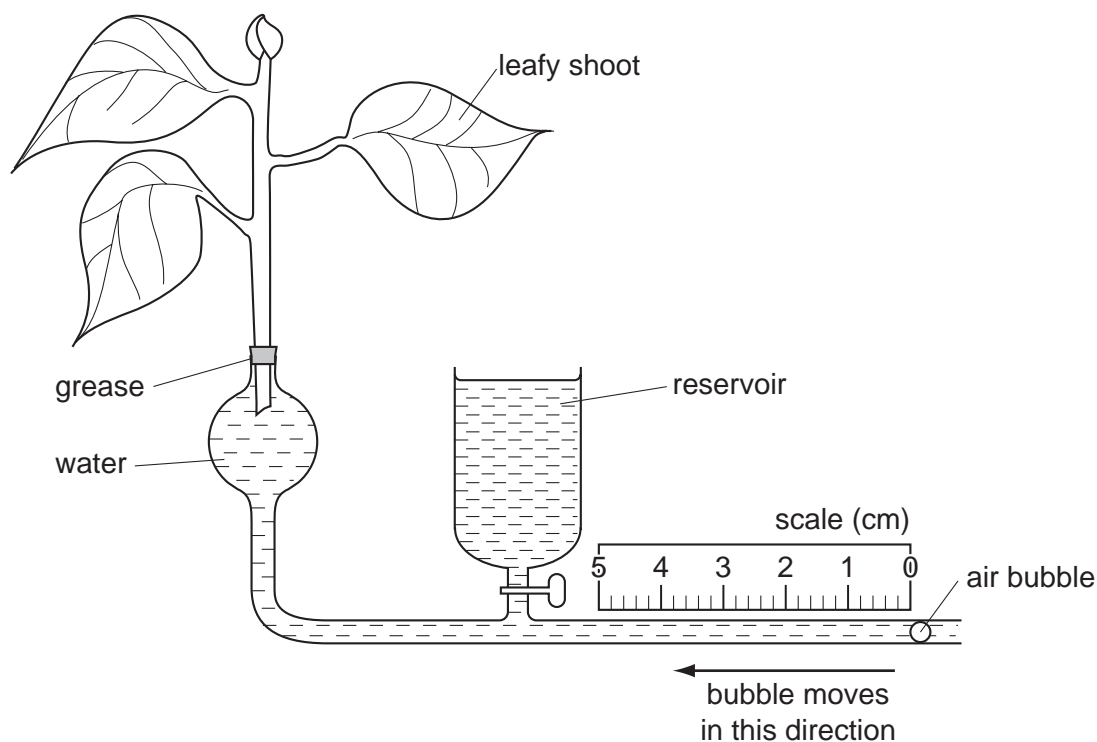

**Fig. 4.1**

- (a) The student prepared the shoot by cutting the stem under water.
- He placed the shoot in the rubber tubing at the top of the apparatus as shown in Fig. 4.1.
  - He added water from the reservoir to move the bubble to the zero mark.
  - He then started timing.
  - He read the position of the bubble every minute for three minutes and recorded the readings in Table 4.1.

Table 4.1

condition of leaves	time / minutes	reading on scale / cm	distance moved by bubble per minute / cm	average distance moved by bubble per minute / cm
untreated	1			
	2			
	3			

(i) Take the readings from the scales illustrated in Fig. 4.2 and record them in Table 4.1. Read the value from the left side of the bubble. [1]

(ii) Calculate the distance moved by the bubble during each minute and enter the values in column 4 of Table 4.1. [1]

(iii) Using the three values found in (a)(ii) calculate the average distance moved by the bubble per minute and enter this value in column 5 of Table 4.1. [1]

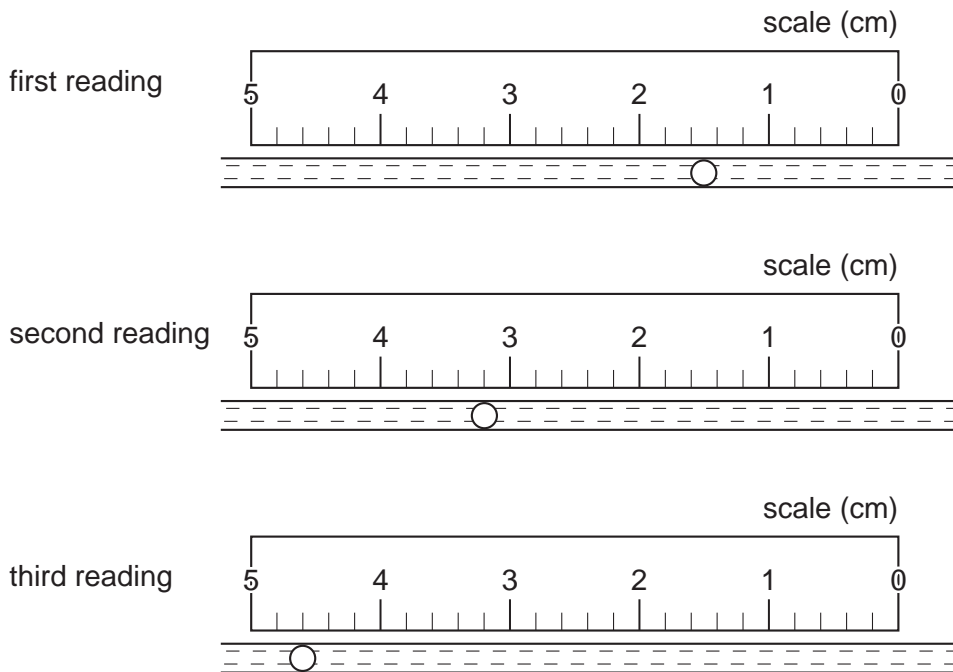
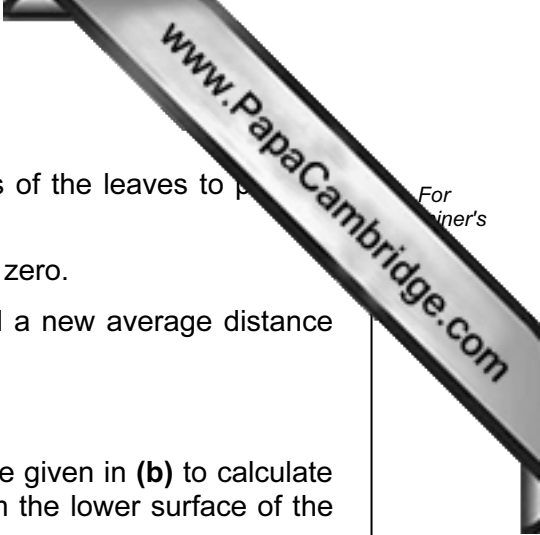

Fig. 4.2



(b) The student then applied grease to all of the upper surfaces of the leaves to prevent loss of water vapour.

- He added water from the reservoir to return the bubble to zero.
- He repeated the procedure as in part (a) and calculated a new average distance moved by the bubble per minute.

This new value was 1.2 cm.

(i) Use the average value from (a)(iii) and the average value given in (b) to calculate the percentage of water vapour loss that took place from the lower surface of the leaf.

percentage loss from lower surface ..... [2]

(ii) The student concluded that the rest of the water vapour was lost from the upper surface of the leaf.

Describe what the student could do to confirm this.

.....  
..... [1]

(c) Study column 4 of Table 4.1. The three values for the distance the bubble moved per minute are not identical to each other.

Suggest **two** environmental conditions that could cause the differences.

first condition .....

.....

second condition .....

..... [2]

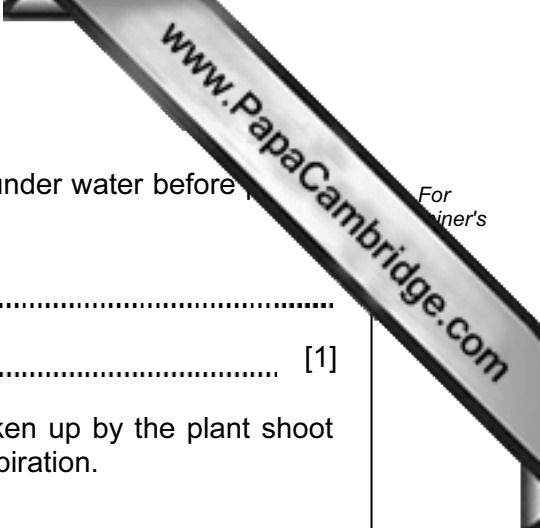

(d) (i) Explain why the student cut the stem of the leafy shoot under water before putting it into the apparatus.

.....  
..... [1]

(ii) Suggest a possible reason why the amount of water taken up by the plant shoot may **not** be exactly the same as the amount lost by transpiration.

.....  
..... [1]



- 5 A student was given five bottles, labelled **A – E**. Each bottle contains one of the following solutions: sodium carbonate, sodium chloride, sodium hydroxide, sodium nitrate or sodium sulfate.

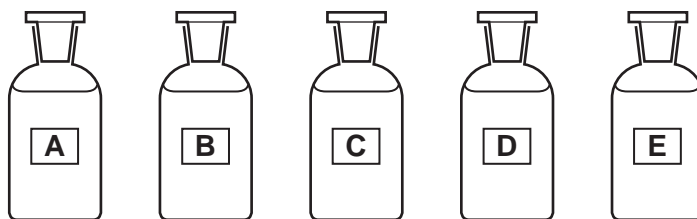

**Fig. 5.1**

The student used the Test Plan, Fig. 5.2, shown on page 18 to identify the solutions. He carried out four tests on the solutions, recorded his observations and named the solutions.

On the Test Plan, some of the student's work has been deleted.

Study the Test Plan over the page and then answer the questions that follow it.

**Do not write anything on page 18.**

Do not write anything on this page.

TEST PLAN

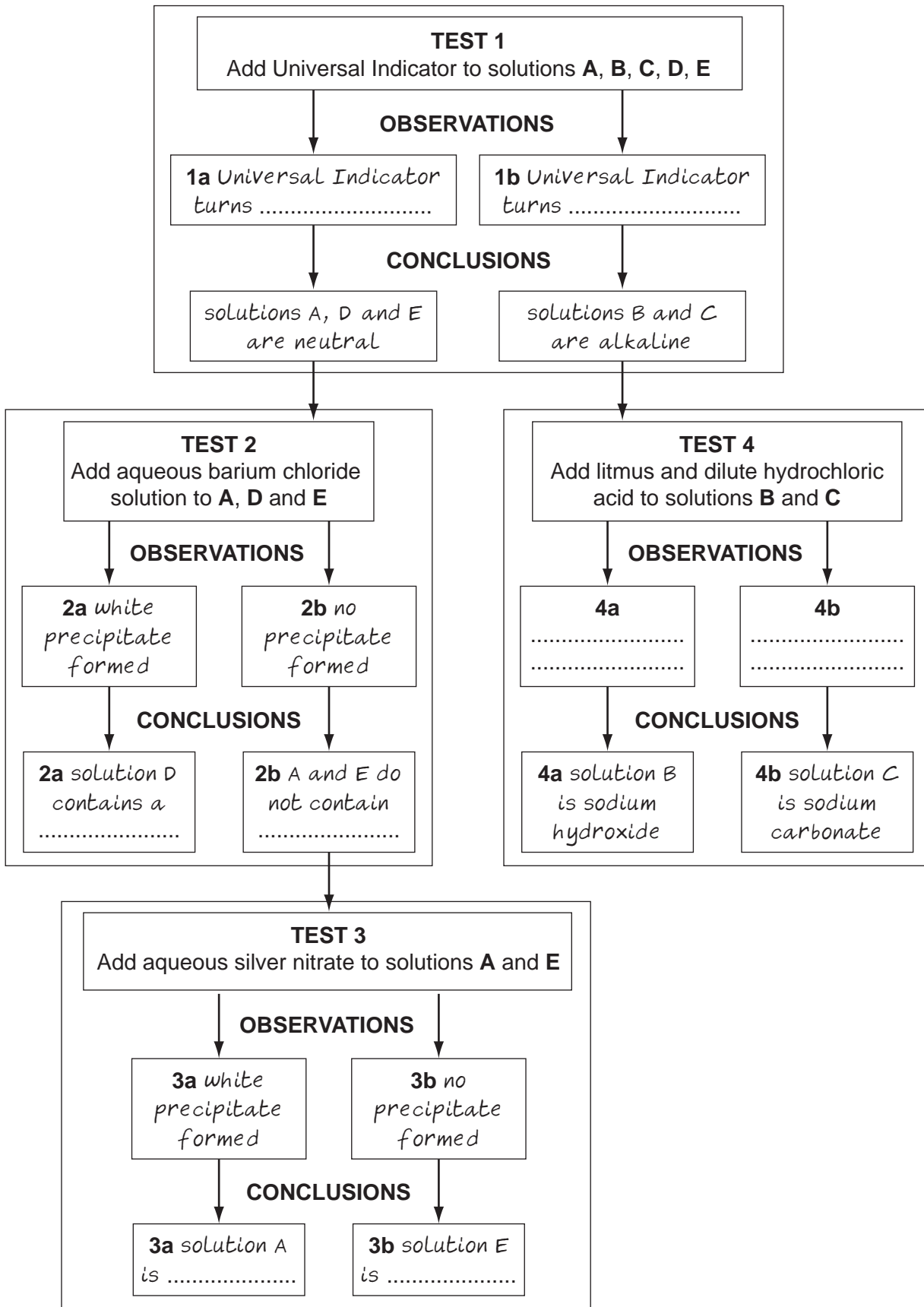

Fig. 5.2

(a) The student added Universal Indicator to the five solutions. Use the conclusions from **Test 1** in the test plan to help you to write **observations 1a** and **1b**.

**observation 1a:** Universal Indicator turned .....

**observation 1b:** Universal Indicator turned ..... [2]

(b) In **Test 2**, the student added aqueous barium chloride solution to solutions **A**, **D** and **E**. He recorded **observation 2a** and **observation 2b**. Then he named liquid **D**.

Suggest the name of liquid **D** ..... [1]

(c) In **Test 3**, the student added aqueous silver nitrate to solutions **A** and **E**. He recorded **observation 3a** and **observation 3b**. These observations helped him name solutions **A** and **E**.

Suggest the name of solution **A** .....

Suggest the name of solution **E** ..... [2]

(d) In **Test 4** the student added litmus solution followed by dilute hydrochloric acid to solutions **B** and **C** until there was no further reaction. He recorded **observation 4a** and **observation 4b**.

He concluded that solution **B** is sodium carbonate, and solution **C** is sodium hydroxide.

(i) What did the student record for **observation 4a**?

.....  
..... [1]

(ii) What did the student record for **observation 4b**?

.....  
..... [2]

(e) (i) Name the white precipitate seen in **Test 2**.

white precipitate ..... [1]

(ii) Explain what is meant by a *precipitate*.

.....  
..... [1]

- 6 The science teacher has given a student a filament lamp that is made for use 240 volt electricity supply.

The filament of the lamp is made from tungsten, a metal that has a very high melting point. The filament glows white hot when current passes through it using a 240 volt supply.

The resistance of tungsten metal is altered when its temperature is changed.

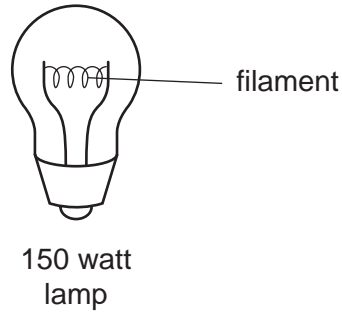

Fig. 6.1

- (a) (i) Complete the sentence to show the main energy changes that occur when the lamp is switched on.

electrical energy → ..... and ..... [2]

- (ii) What gas is contained in the lamp to prevent the filament burning out when it becomes very hot?

..... [1]

The student connects the lamp in the circuit shown in Fig. 6.2. An ammeter, **A**, is used to find the current and a voltmeter, **V**, is used to find the applied voltage.

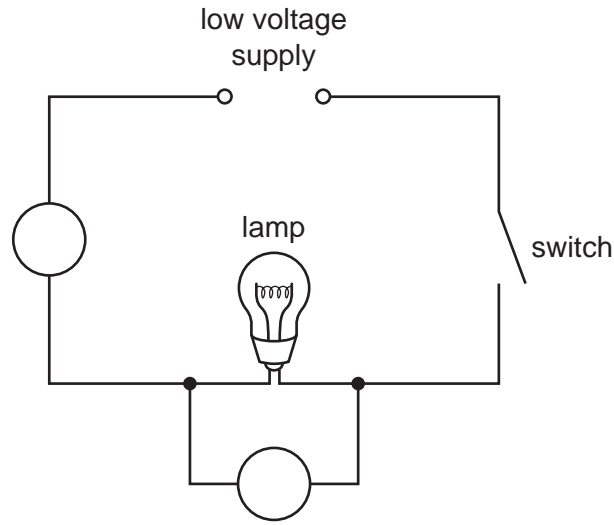

**Fig. 6.2**

- (b) To show where the ammeter and voltmeter should be placed in the circuit, write **A** and **V** in the correct places on Fig. 6.2. [1]

The student closes the switch. The lamp does not light up, but the meters show readings. The ammeter reading immediately reaches a maximum.

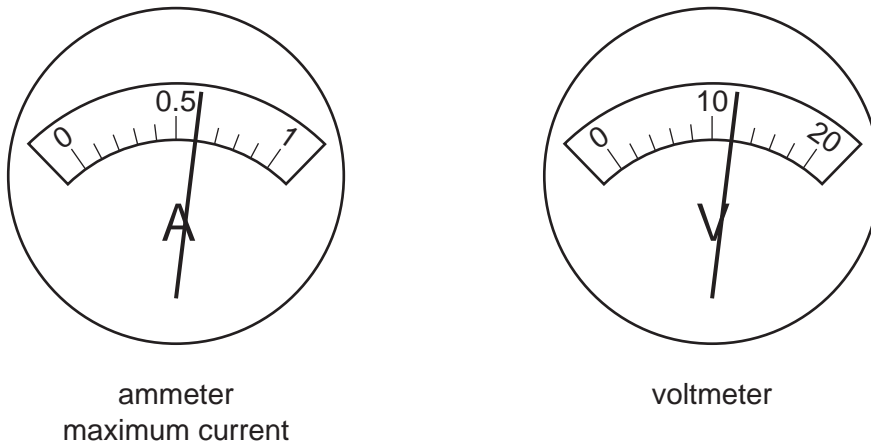
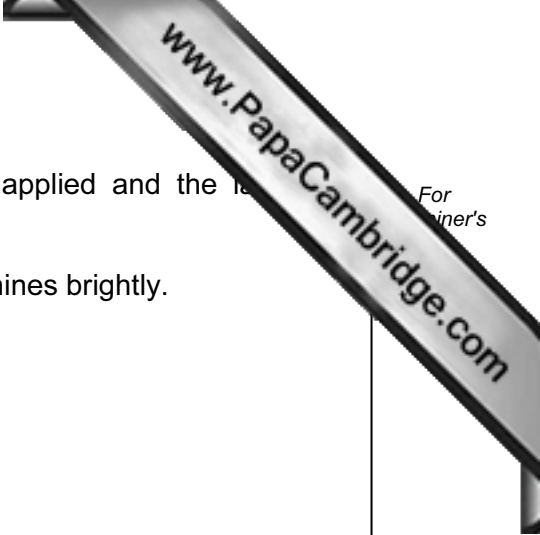

**Fig. 6.3**

- (c) Read the meters in Fig. 6.3 to the nearest 0.1 amp and 1 volt and record the readings in Table 6.1. [2]

**Table 6.1**

maximum current / A	applied voltage / V



- (d) (i) The lamp uses 150 watts of power when 240 volts is applied and the lamp is shining brightly.

Calculate the current passing through the lamp when it shines brightly.

Use the formula

$$\text{current in amps} = \frac{\text{power in watts}}{\text{applied voltage}}$$

current passing through the lamp = ..... A [1]

- (ii) Compare the voltage and current shown in Table 6.1 and your answer to (d)(i).

Suggest how the resistance of the tungsten filament changes when the filament is glowing brightly.

.....  
 ..... [1]

- (e) European governments do not allow shops to sell filament lamps for use in homes. This is because more efficient lamps are available, such as fluorescent lamps.

Explain why the use of filament lamps is an inefficient way to produce light and how their use contributes to global warming.

.....  
 .....  
 ..... [2]



