

COMBINED SCIENCE

0653/11

Paper 1 Multiple Choice

May/June 2015

45 minutes

Additional Materials: Multiple Choice Answer Sheet
Soft clean eraser
Soft pencil (type B or HB is recommended)

* 7 9 7 3 8 6 2 4 0 5 *

READ THESE INSTRUCTIONS FIRST

Write in soft pencil.

Do not use staples, paper clips, glue or correction fluid.

Write your name, Centre number and candidate number on the Answer Sheet in the spaces provided unless this has been done for you.

DO NOT WRITE IN ANY BARCODES.

There are **forty** questions on this paper. Answer **all** questions. For each question there are four possible answers **A, B, C** and **D**.

Choose the **one** you consider correct and record your choice in **soft pencil** on the separate Answer Sheet.

Read the instructions on the Answer Sheet very carefully.

Each correct answer will score one mark. A mark will not be deducted for a wrong answer.

Any rough working should be done in this booklet.

A copy of the Periodic Table is printed on page 20.

Electronic calculators may be used.

This document consists of **17** printed pages and **3** blank pages.

1 A biologist keeps a potted plant in a laboratory.

Which feature of the potted plant shows that it is a living organism?

- A It grows larger over time.
- B It has green leaves.
- C The compost in the pot dries after he waters it.
- D The stems contain xylem.

2 The diagram shows a palisade cell.

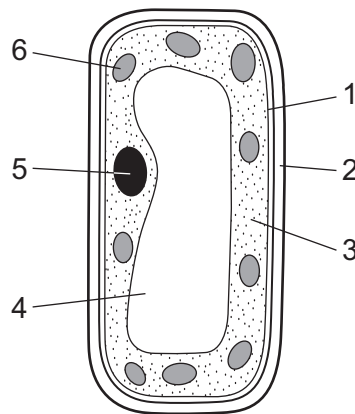

Which parts are found in plant cells and **not** in animal cells?

	1	2	3	4	5	6
A	✓	x	✓	✓	x	x
B	✓	x	✓	x	✓	x
C	x	✓	x	✓	x	✓
D	x	✓	x	x	✓	✓

3 Which substances may diffuse into and out of plant cells?

	into plant cells	out of plant cells
A	chlorophyll	oxygen
B	oxygen	water
C	starch	chlorophyll
D	water	starch

- 4 Proteins that function as biological catalysts are called
- A enzymes
 - B hormones
 - C solvents
 - D vitamins
- 5 The diagram shows a section through part of a leaf.

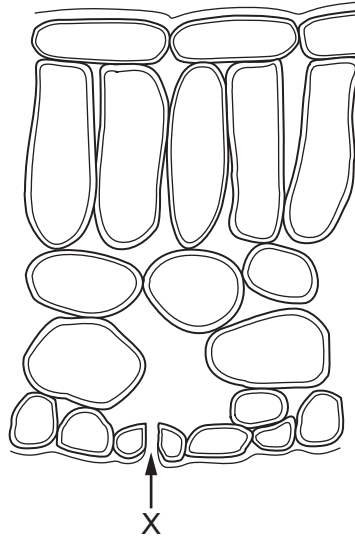

The leaf is photosynthesising in bright light.

What enters the leaf at X?

- A carbon dioxide
- B light
- C oxygen
- D water

- 6 Diagram 1 shows a water plant exposed to sunlight.

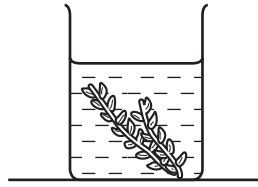
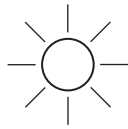

diagram 1

What change would take place if a black box is placed over the plant, as in diagram 2, and left for eight hours?

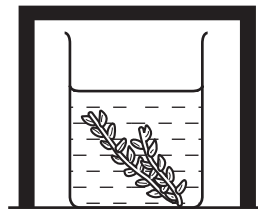
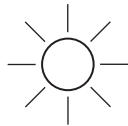
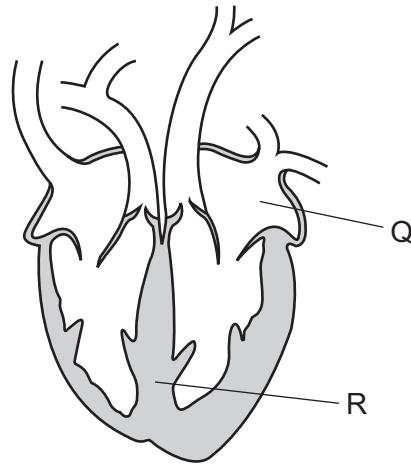

diagram 2

- A Carbon dioxide production would fall.
 - B Oxygen production would fall.
 - C Stomata would open wider.
 - D Respiration would stop.
- 7 A tree has lost most of its leaves.
- How does this affect the rate at which water is taken up by the trees?
- A Water uptake decreases but does not stop.
 - B Water uptake increases.
 - C Water uptake remains the same.
 - D Water uptake stops.

- 8 The diagram shows a heart in section and some of its blood vessels.



What are the parts Q and R?

	Q	R
A	aorta	septum
B	aorta	vena cava
C	atrium	septum
D	atrium	vena cava

- 9 *Monstera* is a climbing plant. Some of its shoots grow away from light, which helps the plant to find support.

What is this an example of?

- A** geotropism
- B** photosynthesis
- C** phototropism
- D** respiration

- 10 A healthy person does not eat for several hours but then has a meal rich in carbohydrates. Which graph shows how the person's blood sugar level changes after the meal?

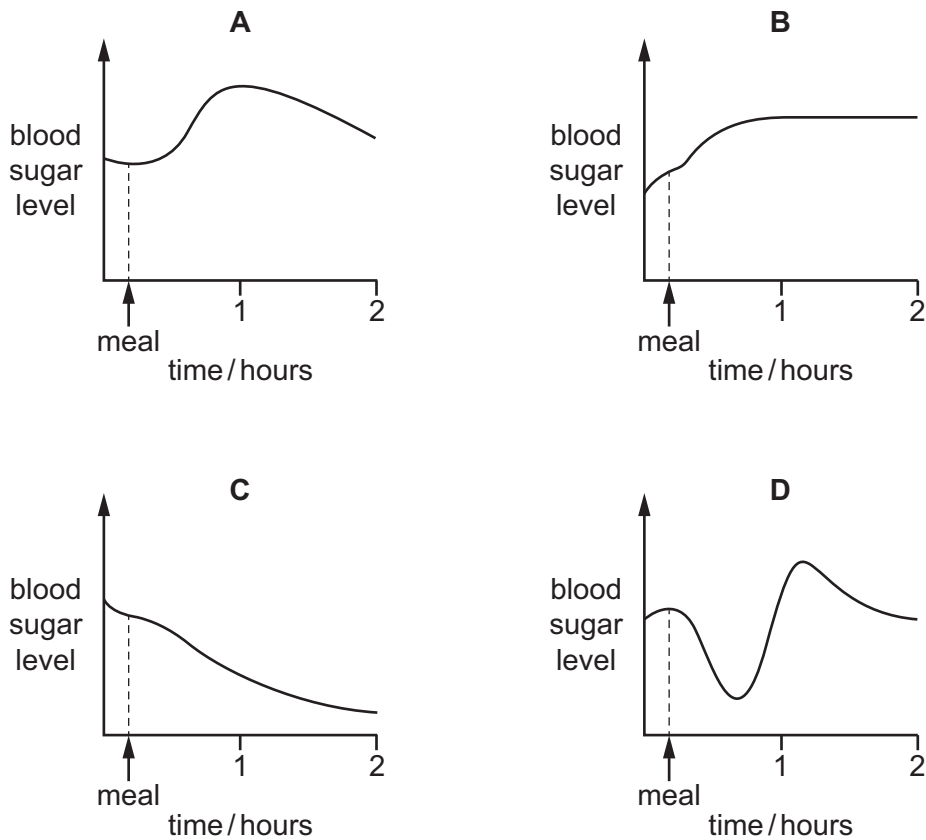

- 11 The diagram shows a side view of the female reproductive system in a human.

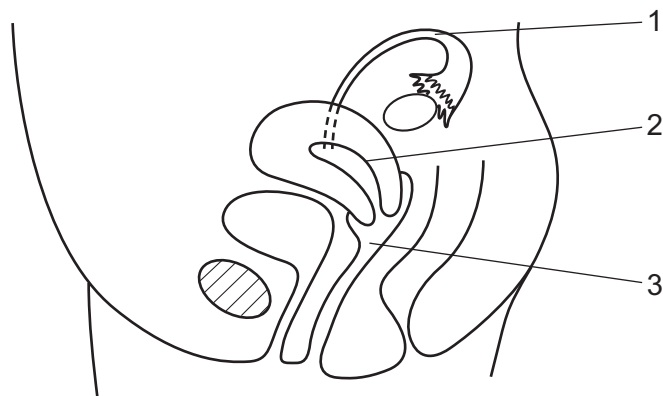

Where do fertilisation and implantation occur?

	fertilisation	implantation
A	1	2
B	2	1
C	2	3
D	3	2

12 The diagram shows the thickness of the uterus lining of a woman over a 4-week period.

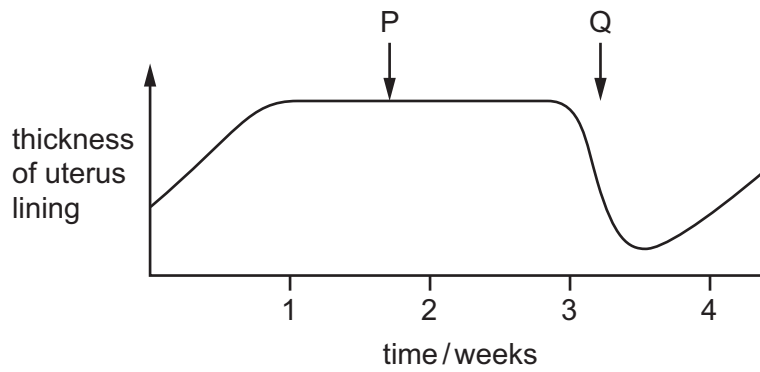

What happens at P and Q?

	P	Q
A	fertilisation	ovulation
B	menstruation	fertilisation
C	menstruation	ovulation
D	ovulation	menstruation

13 An oxpecker bird perches on the back of a buffalo while the buffalo feeds on grass. The bird eats ticks that feed on the blood of the buffalo.

Which food chain represents these feeding relationships?

- A** grass → buffalo → oxpecker → ticks
- B** grass → buffalo → ticks → oxpecker
- C** oxpecker → ticks → buffalo → grass
- D** ticks → oxpecker → buffalo → grass

14 Which method is used to obtain a solid salt from the salt solution?

- A** crystallisation
- B** distillation
- C** filtration
- D** fractional distillation

15 Fluorine and chlorine are in Group VII of the Periodic Table.

Which number increases by eight from fluorine to chlorine?

- A the number of atoms in one molecule
- B the number of electrons in one atom
- C the number of electrons in one molecule
- D the number of nucleons in one atom

16 The structure of an organic compound is shown.

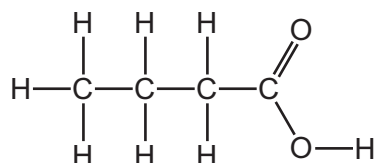

What is the formula of the compound?

- A $\text{C}_3\text{H}_8\text{O}_2$ B $\text{C}_4\text{H}_8\text{O}$ C $\text{C}_4\text{H}_8\text{O}_2$ D $\text{C}_3\text{H}_7\text{O}_2$

17 Which substances are formed at the electrodes during the electrolysis of aqueous copper chloride?

	anode	cathode
A	chlorine	copper
B	chlorine	hydrogen
C	copper	chlorine
D	hydrogen	copper

18 Sherbet is a mixture of citric acid and sodium hydrogencarbonate.

When sherbet is eaten, the chemicals react and cool the tongue.

Which word describes this type of reaction?

- A combustion
- B crystallisation
- C endothermic
- D exothermic

- 19 The diagram shows equal masses of magnesium added to equal volumes of acid of equal concentration.

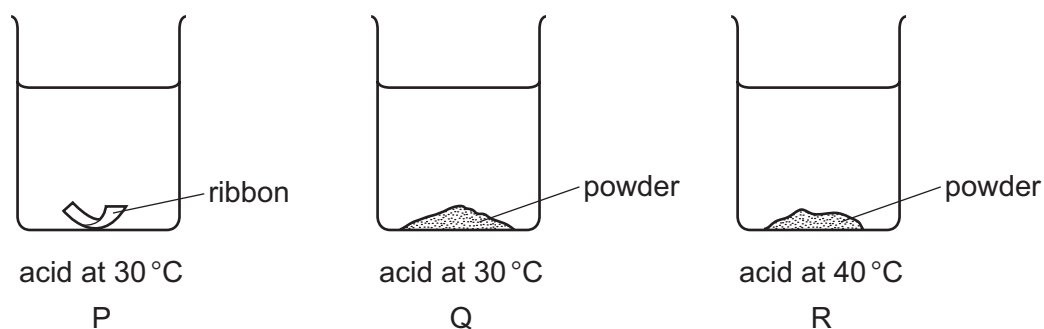

What is the order of the speed of reaction?

	fastest	→	slowest
A	P	R	Q
B	Q	R	P
C	R	P	Q
D	R	Q	P

- 20 In the blast furnace, iron(III) oxide reacts with carbon forming iron and carbon monoxide.

What happens to the iron(III) oxide?

- A** It is oxidised by gaining oxygen.
B It is oxidised by losing oxygen.
C It is reduced by gaining oxygen.
D It is reduced by losing oxygen.

- 21 The table shows the results of tests on an aqueous solution of X.

test	result
blue litmus paper	turns red
aqueous silver nitrate	white precipitate formed

What is X?

- A** HCl **B** HNO_3 **C** NaCl **D** NaOH

22 Which element has similar chemical properties to bromine?

- A argon
- B iodine
- C selenium
- D sulfur

23 An electrical cable contains a copper wire surrounded by a layer of plastic.

Which properties explain why copper and plastic are used in this cable?

	copper	plastic
A	electrical conductor	electrical insulator
B	high melting point	low melting point
C	no reaction with acids	no reaction with acids
D	shiny surface	dull surface

24 A new alloy is resistant to corrosion.

It costs about the same as aluminium but it is slightly poisonous.

Its density, compared with stainless steel and aluminium, is shown.

	aluminium	new alloy	stainless steel
<u>density</u> g/cm ³	2.7	2.8	7.9

What is this new alloy used to make?

- A aircraft frames
- B cutlery
- C electrical insulators
- D food containers

25 The diagram shows an element being added to cold water to form a gas and an alkali.

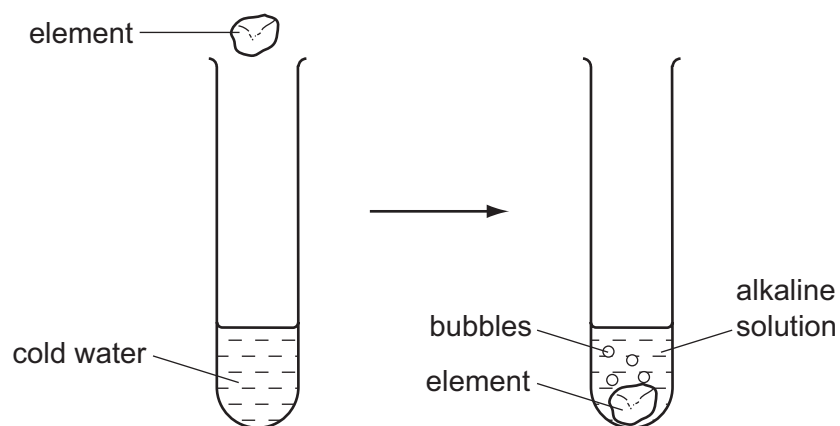

What is the element?

- A calcium
- B carbon
- C copper
- D sulfur

26 In which test-tube does a chemical change take place most quickly?

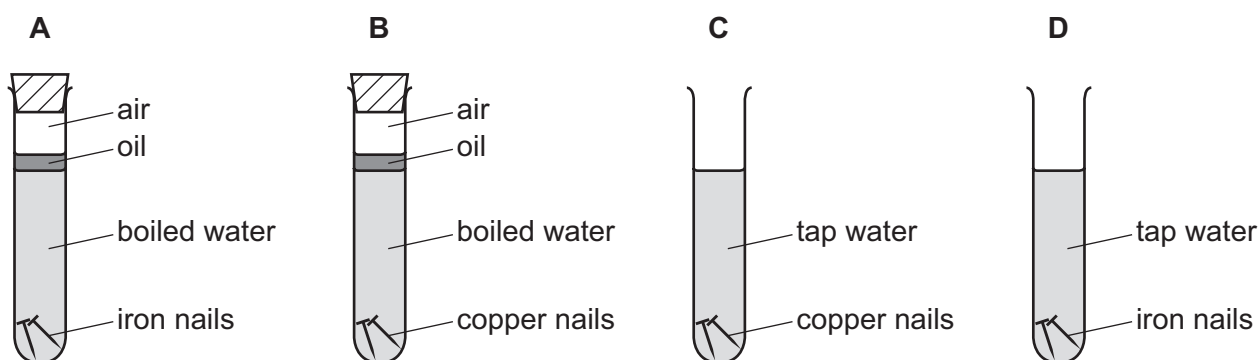

27 Which compound is the main constituent of natural gas?

- A butane
- B ethane
- C methane
- D propane

28 An athlete runs 10 000 metres in 30 minutes.

What is her average speed?

- A 3 km/hour
- B 5 km/hour
- C 10 km/hour
- D 20 km/hour

29 A shop-keeper places **two** identical blocks of cheese on a balance.

The combined mass of the two blocks of cheese is 240 g.

Each block measures 2.0 cm × 5.0 cm × 10.0 cm.

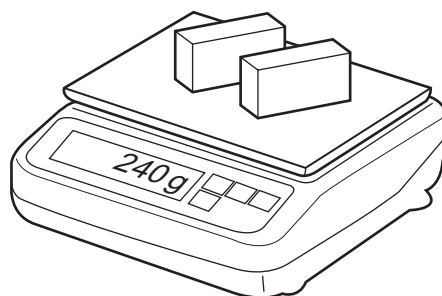

What is the density of the cheese?

- A 0.42 g/cm³
- B 0.83 g/cm³
- C 1.2 g/cm³
- D 2.4 g/cm³

30 The speed of a car increases as it moves up a hill.

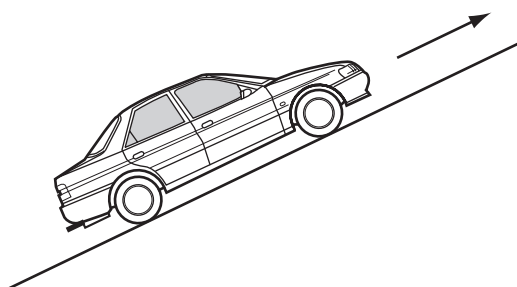

Which energy changes are taking place?

	gravitational energy	kinetic energy
A	decreasing	decreasing
B	increasing	decreasing
C	decreasing	increasing
D	increasing	increasing

31 Cold water evaporates as molecules leave it.

Which molecules leave the water and from which part of the water do they leave?

	molecules that leave the water	where they leave from
A	least energetic	the surface only
B	least energetic	throughout the water
C	most energetic	the surface only
D	most energetic	throughout the water

32 The table shows the melting points and boiling points of four substances.

Which substance is a liquid at a room temperature of 20 °C?

	melting point/°C	boiling point/°C
A	-101	-35
B	-39	357
C	30	2100
D	327	1750

33 Which row is correct?

	conduction of heat	convection of heat
A	can happen in a solid	can happen in a solid
B	can happen in a solid	only happens in liquids and gases
C	only happens in liquids and gases	can happen in a solid
D	only happens in liquids and gases	only happens in liquids and gases

34 A student shakes one end of a long rope up and down. A wave travels along the direction shown.

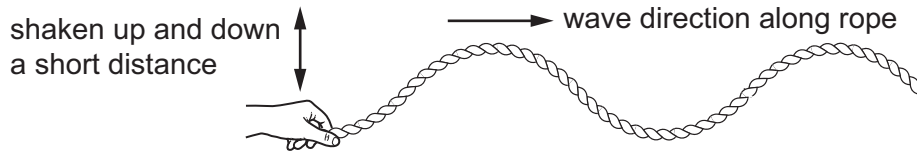

The student now moves the rope up and down through a larger distance. He also shakes it fewer times each minute.

Which row shows the effects of these two changes?

	amplitude of the wave	frequency of the wave
A	decreases	decreases
B	decreases	increases
C	increases	decreases
D	increases	increases

35 Which diagram shows a ray of light passing through a glass block in air?

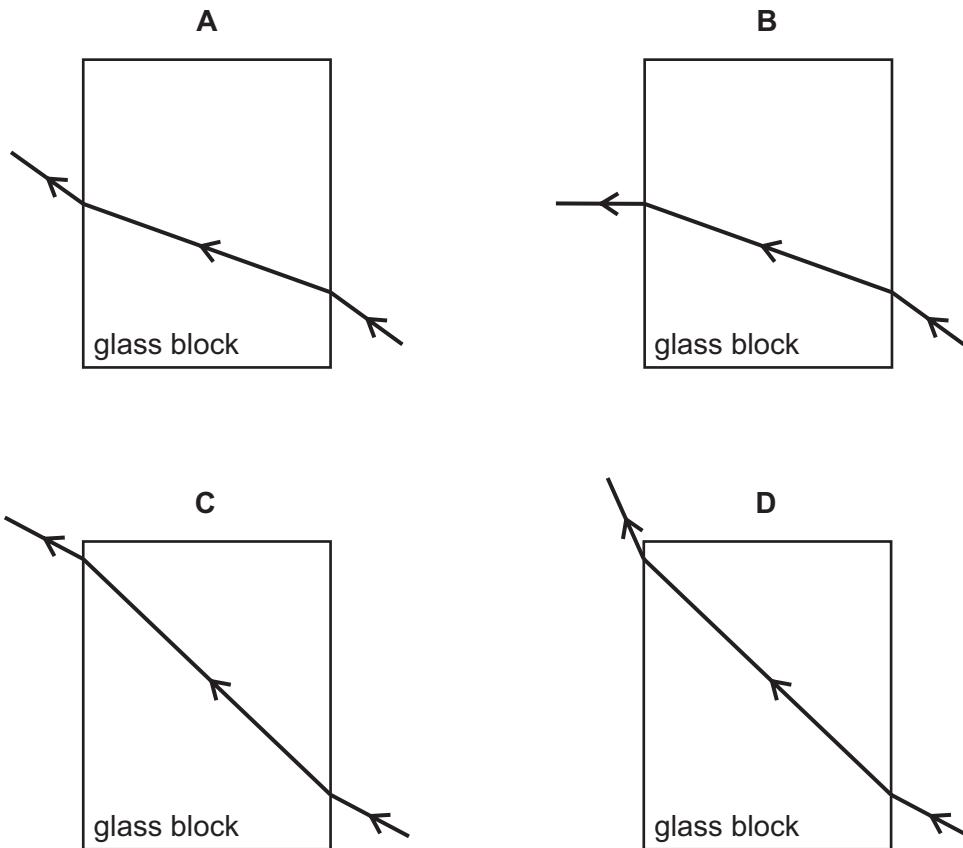

- 36 A filament lamp is used in a zoo to keep young animals warm.

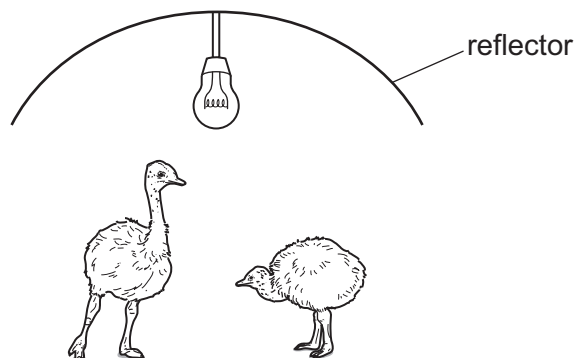

What are the main types of wave given out by the lamp?

- A visible light and infra-red
 - B visible light and microwaves
 - C visible light and radio waves
 - D visible light and X-rays
- 37 A loudspeaker is made to vibrate at four different frequencies.

Which frequency **cannot** produce a sound that a human can hear?

- A 60 Hz B 600 Hz C 6.0 kHz D 60 kHz

- 38 A mains circuit can safely supply a current of 40 A.

A hairdryer takes 2 A. It is connected to the circuit by a lead which can safely carry up to 5 A.

Which fuse should be used to protect the hairdryer?

- A 1 A fuse B 3 A fuse C 10 A fuse D 50 A fuse

39 A voltmeter and an ammeter are used to determine the resistance of a lamp.

Which circuit shows the meters connected to take the necessary measurements?

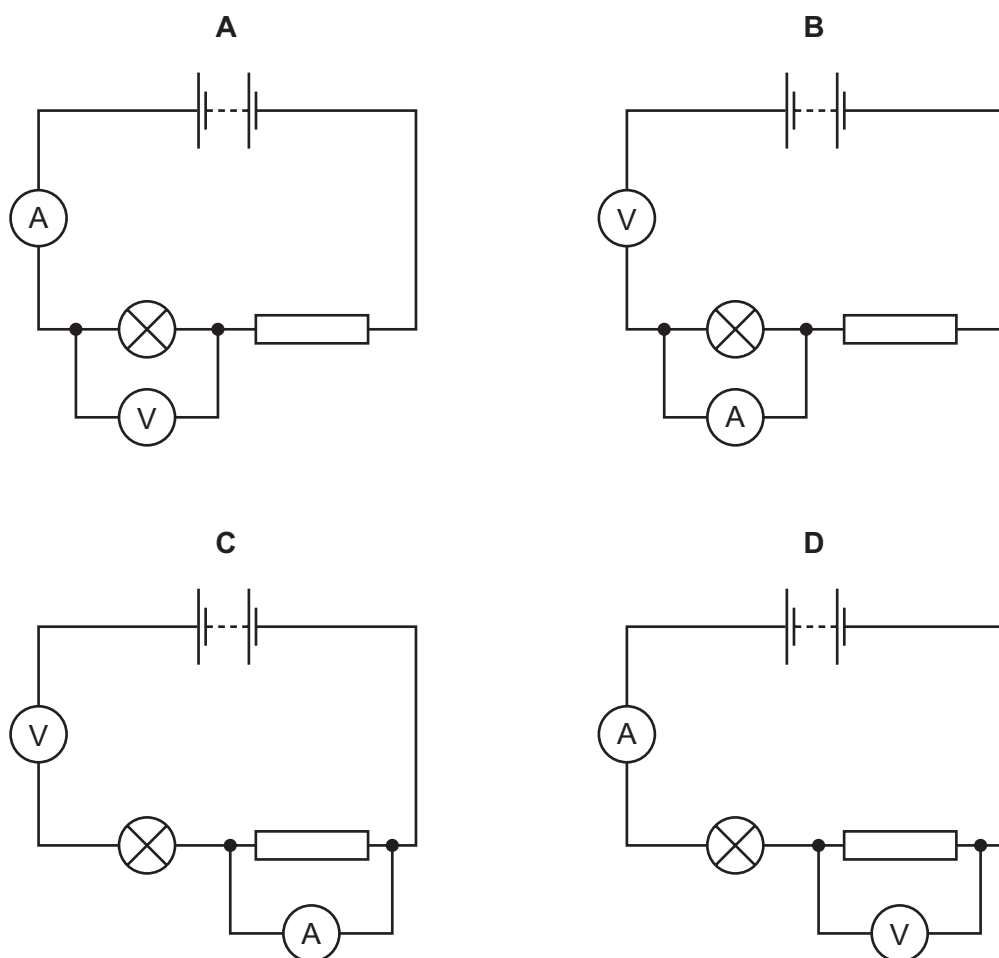

40 The diagram shows a circuit with four identical bulbs P, Q, R and S.

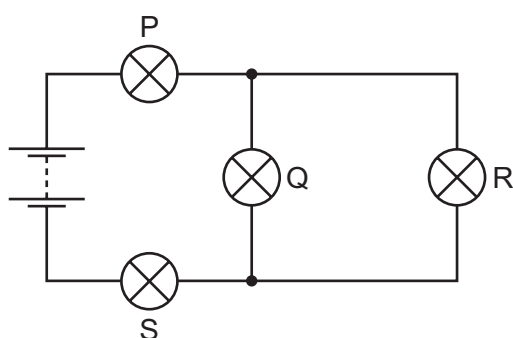

Which statement about the brightness of the bulbs is correct?

- A P is the same brightness as Q.
- B P is the same brightness as S.
- C Q is brighter than S.
- D R is brighter than P.

DATA SHEET
The Periodic Table of the Elements

		Group																																																																																																																																																																																																																																																																																																																																																																																																																																																																								
I	II	III	IV	V	VI	VII	0																																																																																																																																																																																																																																																																																																																																																																																																																																																																			
7 Li Lithium 3	9 Be Beryllium 4	1 H Hydrogen 1	11 B Boron 5	12 C Carbon 6	14 N Nitrogen 7	16 O Oxygen 8	19 F Fluorine 9	20 Ne Neon 10	23 Na Sodium 11	24 Mg Magnesium 12	27 Al Aluminium 13	28 Si Silicon 14	31 P Phosphorus 15	32 S Sulfur 16	35.5 Cl Chlorine 17	40 Ar Argon 18	39 K Potassium 19	40 Ca Calcium 20	45 Sc Scandium 21	48 Ti Titanium 22	51 V Vanadium 23	52 Cr Chromium 24	55 Mn Manganese 25	56 Fe Iron 26	59 Co Cobalt 27	59 Ni Nickel 28	64 Cu Copper 29	65 Zn Zinc 30	70 Ga Gallium 31	73 Ge Germanium 32	75 As Arsenic 33	79 Se Selenium 34	80 Br Bromine 35	84 Kr Krypton 36	85 Rb Rubidium 37	88 Sr Strontium 38	89 Y Yttrium 39	91 Zr Zirconium 40	93 Nb Niobium 41	96 Mo Molybdenum 42	101 Ru Ruthenium 44	106 Pd Palladium 46	108 Ag Silver 47	112 Cd Cadmium 48	115 In Indium 49	119 Sn Tin 50	122 Sb Antimony 51	128 Te Tellurium 52	131 Xe Xenon 54	133 Cs Caesium 55	137 Ba Barium 56	139 La Lanthanum 57	178 Hf Hafnium 72	181 Ta Tantalum 73	184 W Tungsten 74	186 Re Rhenium 75	190 Os Osmium 76	192 Ir Iridium 77	195 Pt Platinum 78	197 Au Gold 79	201 Hg Mercury 80	204 Tl Thallium 81	207 Pb Lead 82	209 Bi Bismuth 83	210 Po Polonium 84	210 At Astatine 85	226 Ra Radium 88	227 Ac Actinium 89	227 Fr Francium 87	226 Ra Radium 88	227 Ac Actinium 89	232 Th Thorium 90	232 Pa Protactinium 91	238 U Uranium 92	238 Np Neptunium 93	238 Pu Plutonium 94	238 Am Americium 95	238 Cm Curium 96	238 Bk Berkelium 97	238 Cf Californium 98	238 Es Einsteinium 99	238 Fm Fermium 100	238 Md Mendelevium 101	238 No Nobelium 102	238 Lr Lawrencium 103	238 Lu Lutetium 71	238 Yb Ytterbium 70	238 Er Erbium 68	238 Tm Thulium 69	238 Dy Dysprosium 66	238 Ho Holmium 67	238 Er Erbium 68	238 Ho Holmium 67	238 Dy Dysprosium 66	238 Lu Lutetium 71	238 Yb Ytterbium 70	238 Lu Lutetium 71	238 Er Erbium 68	238 Tm Thulium 69	238 Dy Dysprosium 66	238 Ho Holmium 67	238 Er Erbium 68	238 Lu Lutetium 71	238 Yb Ytterbium 70	238 Lu Lutetium 71	238 Er Erbium 68	238 Tm Thulium 69	238 Dy Dysprosium 66	238 Ho Holmium 67	238 Er Erbium 68	238 Lu Lutetium 71	238 Yb Ytterbium 70	238 Lu Lutetium 71	238 Er Erbium 68	238 Tm Thulium 69	238 Dy Dysprosium 66	238 Ho Holmium 67	238 Er Erbium 68	238 Lu Lutetium 71	238 Yb Ytterbium 70	238 Lu Lutetium 71	238 Er Erbium 68	238 Tm Thulium 69	238 Dy Dysprosium 66	238 Ho Holmium 67	238 Er Erbium 68	238 Lu Lutetium 71	238 Yb Ytterbium 70	238 Lu Lutetium 71	238 Er Erbium 68	238 Tm Thulium 69	238 Dy Dysprosium 66	238 Ho Holmium 67	238 Er Erbium 68	238 Lu Lutetium 71	238 Yb Ytterbium 70	238 Lu Lutetium 71	238 Er Erbium 68	238 Tm Thulium 69	238 Dy Dysprosium 66	238 Ho Holmium 67	238 Er Erbium 68	238 Lu Lutetium 71	238 Yb Ytterbium 70	238 Lu Lutetium 71	238 Er Erbium 68	238 Tm Thulium 69	238 Dy Dysprosium 66	238 Ho Holmium 67	238 Er Erbium 68	238 Lu Lutetium 71	238 Yb Ytterbium 70	238 Lu Lutetium 71	238 Er Erbium 68	238 Tm Thulium 69	238 Dy Dysprosium 66	238 Ho Holmium 67	238 Er Erbium 68	238 Lu Lutetium 71	238 Yb Ytterbium 70	238 Lu Lutetium 71	238 Er Erbium 68	238 Tm Thulium 69	238 Dy Dysprosium 66	238 Ho Holmium 67	238 Er Erbium 68	238 Lu Lutetium 71	238 Yb Ytterbium 70	238 Lu Lutetium 71	238 Er Erbium 68	238 Tm Thulium 69	238 Dy Dysprosium 66	238 Ho Holmium 67	238 Er Erbium 68	238 Lu Lutetium 71	238 Yb Ytterbium 70	238 Lu Lutetium 71	238 Er Erbium 68	238 Tm Thulium 69	238 Dy Dysprosium 66	238 Ho Holmium 67	238 Er Erbium 68	238 Lu Lutetium 71	238 Yb Ytterbium 70	238 Lu Lutetium 71	238 Er Erbium 68	238 Tm Thulium 69	238 Dy Dysprosium 66	238 Ho Holmium 67	238 Er Erbium 68	238 Lu Lutetium 71	238 Yb Ytterbium 70	238 Lu Lutetium 71	238 Er Erbium 68	238 Tm Thulium 69	238 Dy Dysprosium 66	238 Ho Holmium 67	238 Er Erbium 68	238 Lu Lutetium 71	238 Yb Ytterbium 70	238 Lu Lutetium 71	238 Er Erbium 68	238 Tm Thulium 69	238 Dy Dysprosium 66	238 Ho Holmium 67	238 Er Erbium 68	238 Lu Lutetium 71	238 Yb Ytterbium 70	238 Lu Lutetium 71	238 Er Erbium 68	238 Tm Thulium 69	238 Dy Dysprosium 66	238 Ho Holmium 67	238 Er Erbium 68	238 Lu Lutetium 71	238 Yb Ytterbium 70	238 Lu Lutetium 71	238 Er Erbium 68	238 Tm Thulium 69	238 Dy Dysprosium 66	238 Ho Holmium 67	238 Er Erbium 68	238 Lu Lutetium 71	238 Yb Ytterbium 70	238 Lu Lutetium 71	238 Er Erbium 68	238 Tm Thulium 69	238 Dy Dysprosium 66	238 Ho Holmium 67	238 Er Erbium 68	238 Lu Lutetium 71	238 Yb Ytterbium 70	238 Lu Lutetium 71	238 Er Erbium 68	238 Tm Thulium 69	238 Dy Dysprosium 66	238 Ho Holmium 67	238 Er Erbium 68	238 Lu Lutetium 71	238 Yb Ytterbium 70	238 Lu Lutetium 71	238 Er Erbium 68	238 Tm Thulium 69	238 Dy Dysprosium 66	238 Ho Holmium 67	238 Er Erbium 68	238 Lu Lutetium 71	238 Yb Ytterbium 70	238 Lu Lutetium 71	238 Er Erbium 68	238 Tm Thulium 69	238 Dy Dysprosium 66	238 Ho Holmium 67	238 Er Erbium 68	238 Lu Lutetium 71	238 Yb Ytterbium 70	238 Lu Lutetium 71	238 Er Erbium 68	238 Tm Thulium 69	238 Dy Dysprosium 66	238 Ho Holmium 67	238 Er Erbium 68	238 Lu Lutetium 71	238 Yb Ytterbium 70	238 Lu Lutetium 71	238 Er Erbium 68	238 Tm Thulium 69	238 Dy Dysprosium 66	238 Ho Holmium 67	238 Er Erbium 68	238 Lu Lutetium 71	238 Yb Ytterbium 70	238 Lu Lutetium 71	238 Er Erbium 68	238 Tm Thulium 69	238 Dy Dysprosium 66	238 Ho Holmium 67	238 Er Erbium 68	238 Lu Lutetium 71	238 Yb Ytterbium 70	238 Lu Lutetium 71	238 Er Erbium 68	238 Tm Thulium 69	238 Dy Dysprosium 66	238 Ho Holmium 67	238 Er Erbium 68	238 Lu Lutetium 71	238 Yb Ytterbium 70	238 Lu Lutetium 71	238 Er Erbium 68	238 Tm Thulium 69	238 Dy Dysprosium 66	238 Ho Holmium 67	238 Er Erbium 68	238 Lu Lutetium 71	238 Yb Ytterbium 70	238 Lu Lutetium 71	238 Er Erbium 68	238 Tm Thulium 69	238 Dy Dysprosium 66	238 Ho Holmium 67	238 Er Erbium 68	238 Lu Lutetium 71	238 Yb Ytterbium 70	238 Lu Lutetium 71	238 Er Erbium 68	238 Tm Thulium 69	238 Dy Dysprosium 66	238 Ho Holmium 67	238 Er Erbium 68	238 Lu Lutetium 71	238 Yb Ytterbium 70	238 Lu Lutetium 71	238 Er Erbium 68	238 Tm Thulium 69	238 Dy Dysprosium 66	238 Ho Holmium 67	238 Er Erbium 68	238 Lu Lutetium 71	238 Yb Ytterbium 70	238 Lu Lutetium 71	238 Er Erbium 68	238 Tm Thulium 69	238 Dy Dysprosium 66	238 Ho Holmium 67	238 Er Erbium 68	238 Lu Lutetium 71	238 Yb Ytterbium 70	238 Lu Lutetium 71	238 Er Erbium 68	238 Tm Thulium 69	238 Dy Dysprosium 66	238 Ho Holmium 67	238 Er Erbium 68	238 Lu Lutetium 71	238 Yb Ytterbium 70	238 Lu Lutetium 71	238 Er Erbium 68	238 Tm Thulium 69	238 Dy Dysprosium 66	238 Ho Holmium 67	238 Er Erbium 68	238 Lu Lutetium 71	238 Yb Ytterbium 70	238 Lu Lutetium 71	238 Er Erbium 68	238 Tm Thulium 69	238 Dy Dysprosium 66	238 Ho Holmium 67	238 Er Erbium 68	238 Lu Lutetium 71	238 Yb Ytterbium 70	238 Lu Lutetium 71	238 Er Erbium 68	238 Tm Thulium 69	238 Dy Dysprosium 66	238 Ho Holmium 67	238 Er Erbium 68	238 Lu Lutetium 71	238 Yb Ytterbium 70	238 Lu Lutetium 71	238 Er Erbium 68	238 Tm Thulium 69	238 Dy Dysprosium 66	238 Ho Holmium 67	238 Er Erbium 68	238 Lu Lutetium 71	238 Yb Ytterbium 70	238 Lu Lutetium 71	238 Er Erbium 68	238 Tm Thulium 69	238 Dy Dysprosium 66	238 Ho Holmium 67	238 Er Erbium 68	238 Lu Lutetium 71	238 Yb Ytterbium 70	238 Lu Lutetium 71	238 Er Erbium 68	238 Tm Thulium 69	238 Dy Dysprosium 66	238 Ho Holmium 67	238 Er Erbium 68	238 Lu Lutetium 71	238 Yb Ytterbium 70	238 Lu Lutetium 71	238 Er Erbium 68	238 Tm Thulium 69	238 Dy Dysprosium 66	238 Ho Holmium 67	238 Er Erbium 68	238 Lu Lutetium 71	238 Yb Ytterbium 70	238 Lu Lutetium 71	238 Er Erbium 68	238 Tm Thulium 69	238 Dy Dysprosium 66	238 Ho Holmium 67	238 Er Erbium 68	238 Lu Lutetium 71	238 Yb Ytterbium 70	238 Lu Lutetium 71	238 Er Erbium 68	238 Tm Thulium 69	238 Dy Dysprosium 66	238 Ho Holmium 67	238 Er Erbium 68	238 Lu Lutetium 71	238 Yb Ytterbium 70	238 Lu Lutetium 71	238 Er Erbium 68	238 Tm Thulium 69	238 Dy Dysprosium 66	238 Ho Holmium 67	238 Er Erbium 68	238 Lu Lutetium 71	238 Yb Ytterbium 70	238 Lu Lutetium 71	238 Er Erbium 68	238 Tm Thulium 69	238 Dy Dysprosium 66	238 Ho Holmium 67	238 Er Erbium 68	238 Lu Lutetium 71	238 Yb Ytterbium 70	238 Lu Lutetium 71	238 Er Erbium 68	238 Tm Thulium 69	238 Dy Dysprosium 66	238 Ho Holmium 67	238 Er Erbium 68	238 Lu Lutetium 71	238 Yb Ytterbium 70	238 Lu Lutetium 71	238 Er Erbium 68	238 Tm Thulium 69	238 Dy Dysprosium 66	238 Ho Holmium 67	238 Er Erbium 68	238 Lu Lutetium 71	238 Yb Ytterbium 70	238 Lu Lutetium 71	238 Er Erbium 68	238 Tm Thulium 69	238 Dy Dysprosium 66	238 Ho Holmium 67	238 Er Erbium 68	238 Lu Lutetium 71	238 Yb Ytterbium 70	238 Lu Lutetium 71	238 Er Erbium 68	238 Tm Thulium 69	238 Dy Dysprosium 66	238 Ho Holmium 67	238 Er Erbium 68	238 Lu Lutetium 71	238 Yb Ytterbium 70	238 Lu Lutetium 71	238 Er Erbium 68