



Cambridge Assessment International Education
Cambridge International General Certificate of Secondary Education (9–1)

CANDIDATE NAME

CENTRE NUMBER

CANDIDATE NUMBER



CO-ORDINATED SCIENCES

0973/61

Paper 6 Alternative to Practical

October/November 2019

1 hour 30 minutes

Candidates answer on the Question Paper.

No Additional Materials are required.

READ THESE INSTRUCTIONS FIRST

Write your centre number, candidate number and name on all the work you hand in.

Write in dark blue or black pen.

You may use an HB pencil for any diagrams or graphs.

Do not use staples, paper clips, glue or correction fluid.

DO NOT WRITE IN ANY BARCODES.

Answer **all** questions.

Electronic calculators may be used.

You may lose marks if you do not show your working or if you do not use appropriate units.

At the end of the examination, fasten all your work securely together.

The number of marks is given in brackets [] at the end of each question or part question.

This document consists of **18** printed pages and **2** blank pages.

1 A student investigates an enzyme controlled reaction.

Catalase is an enzyme that is found inside living cells, such as those found in beans. It catalyses the breakdown of hydrogen peroxide.

Oxygen gas is released during the reaction and a foam is produced.

(a) Procedure

- A student places some liquidised beans in a test-tube.
- He adds some hydrogen peroxide solution and starts a stopclock.
- He measures the time it takes for the foam produced to reach the top of the test-tube.
- He empties the test-tube and rinses it with distilled water.
- He repeats the procedure two more times.
- His stopclock readings are shown in Fig. 1.1.

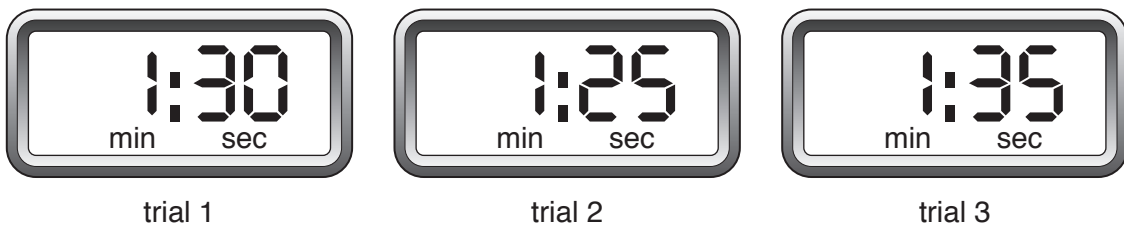

Fig. 1.1

(i) Read the stopclocks in Fig. 1.1.

Record in Table 1.1 the time **in seconds** for each trial.

[2]

(ii) Calculate the average time taken.

Record this value in Table 1.1.

Table 1.1

time taken for foam to reach the top of the test-tube /s			
trial 1	trial 2	trial 3	average

[1]

(iii) State **one** variable that must be kept constant in this experiment.

..... [1]

- (b) Fig. 1.2 shows a test-tube containing liquidised beans and hydrogen peroxide solution.
 Draw on Fig. 1.2 suitable apparatus to collect the oxygen gas produced.

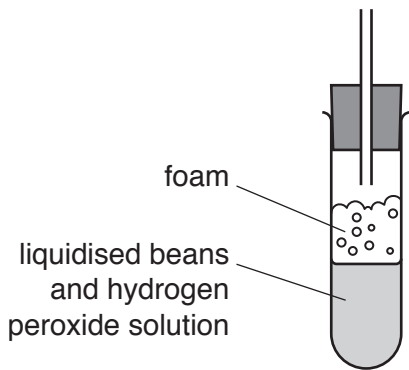

Fig. 1.2

[1]

- (c) Describe the test to identify oxygen gas. Include the observation for a positive result.

test

observation for a positive result

[2]

- (d) The student tests the liquidised beans for their nutrient content.

He uses Benedict's solution and biuret solution.

The liquidised beans test positive with both solutions.

Use this information to complete Table 1.2.

Table 1.2

test solution	colour observed after adding test solution	nutrient content of beans
Benedict's solution		
biuret solution		

[4]

(e) Describe how the student could test a liquid for the presence of fat.

.....
.....
..... [2]

[Total: 13]

2 Photosynthesis takes place in aquatic plants (plants that live in water). Photosynthesis produces bubbles of oxygen gas. The greater the rate of photosynthesis, the faster the oxygen is produced.

A student suggests that the rate of photosynthesis in aquatic plants is affected by the colour of light that the plant receives.

Plan an investigation to see which colour of light produces the greatest rate of photosynthesis in an aquatic plant.

You are given several samples of the same aquatic plant and sources of red light, blue light and green light. You may also use any other common laboratory apparatus.

Do **not** carry out this investigation.

Include in your answer:

- what you would do, including the apparatus you would use
- what you would measure
- what you would control
- how you would use your results to draw a conclusion
- a labelled diagram, if you wish.

.....

.....

.....

.....

.....

.....

.....

.....

.....

..... [7]

- 3 A student investigates the effect of the surface area of a solid on the rate of the reaction. She reacts marble chips (calcium carbonate) with hydrochloric acid.

This reaction produces a gas.

(a) Procedure

- She sets up the apparatus as shown in Fig. 3.1.

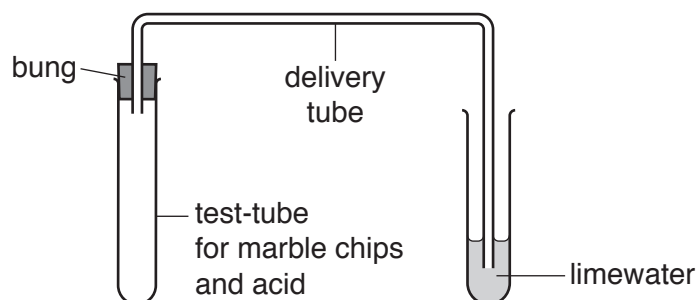

Fig. 3.1

- She removes the bung from the empty test-tube.
- She places 10 marble chips of approximately the same size in the empty test-tube.
- She adds 5 cm³ hydrochloric acid to the marble chips and replaces the bung.
- She immediately starts the stopclock.
- She stops the stopclock when the limewater turns milky.
- She records in Table 3.1 this time t to the nearest second.

She repeats the procedure using 20, 30 and 40 marble chips.

- (i) Fig. 3.2 shows the stopclock reading for 20 marble chips.

Read and record in Table 3.1 this time to the nearest second.



20 marble chips

Fig. 3.2

Table 3.1

number of marble chips	time t /s	rate $\frac{1}{t}$ / $\frac{1}{s}$
10	60	0.017
20		
30	21	0.048
40	11	0.091

[1]

(ii) State the name of the gas which turns limewater milky.

..... [1]

(iii) Describe what the student needs to do to the apparatus and used chemicals between each experiment.

apparatus

.....

used chemicals

.....

[2]

(b) (i) Calculate the rate $\frac{1}{t}$ for 20 marble chips.

Record in Table 3.1 this value to **two** significant figures. [2]

(ii) The surface area of the marble chips increases as the number of chips increases.

Use the information in Table 3.1 to state the relationship between the rate of the reaction and the total surface area of the marble chips.

.....

..... [1]

(c) (i) State **one** variable which is kept constant in this experiment.

..... [1]

(ii) Suggest **one** reason why varying the number of marble chips is **not** a fair way of changing the total surface area.

.....

..... [1]

(iii) Suggest **one** other major source of inaccuracy in the procedure for this experiment.

.....
..... [1]

[Total: 10]

4 A student investigates the properties of compound **H** and identifies the ions in **H**.

- (a) (i) He places 25 cm^3 of distilled water in a large test-tube. He measures the temperature T_1 of this water.

Fig. 4.1 shows the thermometer reading of T_1 .

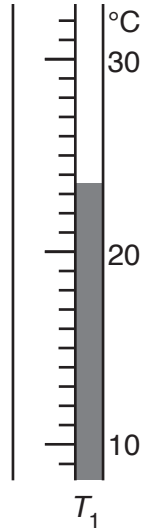

Fig. 4.1

Read and record T_1 to the nearest 0.5°C .

$T_1 = \dots\dots\dots^\circ\text{C}$ [1]

(ii) Procedure

- He adds compound **H** to the water and stirs.
- He measures the highest or lowest temperature T_2 reached by the mixture.
- He keeps this mixture for use in **(b)** and **(c)**.
- He describes the appearance of the mixture as shown in Fig. 4.2.

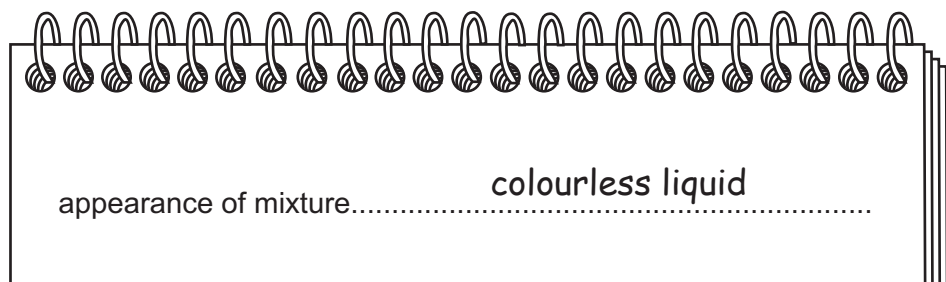

Fig. 4.2

Fig. 4.3 shows the thermometer reading of T_2 .

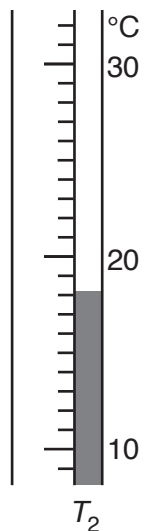

Fig. 4.3

Read and record T_2 to the nearest 0.5°C .

$T_2 = \dots\dots\dots^\circ\text{C}$ [1]

- (iii) Calculate the temperature change ΔT when **H** is added to water in **(a)(ii)**. Include a plus (+) or minus (–) sign as appropriate.

$\Delta T = \dots\dots\dots^\circ\text{C}$ [1]

- (iv) State two conclusions about what happens when **H** is mixed with water. Use the observation in Fig. 4.2 and the calculation in **(a)(iii)**.

conclusion 1

conclusion 2

[2]

- (b) (i) He places some of the mixture from (a)(ii) in a test-tube and adds an equal volume of dilute nitric acid.

He then adds a few drops of barium nitrate solution.

His observations are shown in Fig. 4.4.

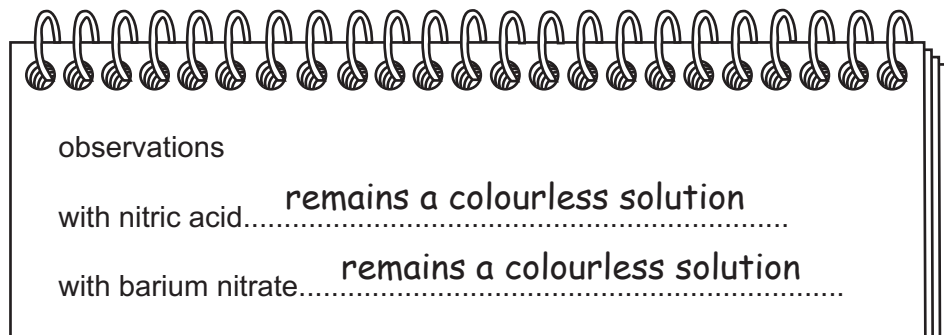

Fig. 4.4

State the conclusions that the student can make from the observations in Fig. 4.4 about the anions present or not present in **H**.

.....
 [2]

- (ii) He places some of the mixture from (a)(ii) in a test-tube and adds an equal volume of dilute nitric acid.

Then he adds a few drops of silver nitrate solution.

His observations are shown in Fig. 4.5.

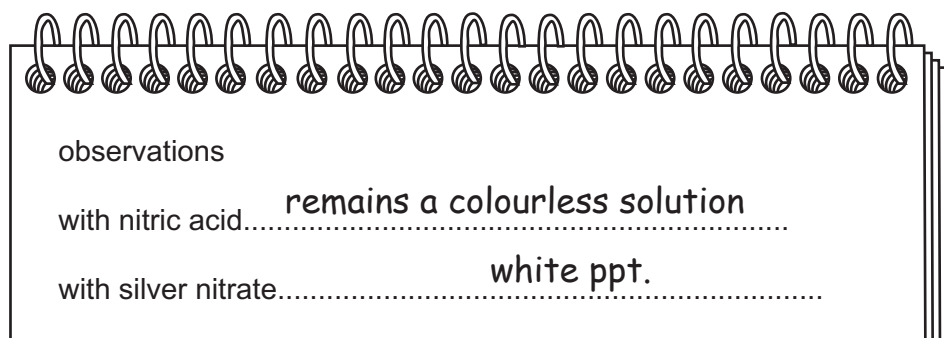

Fig. 4.5

State the conclusions that the student can make from the observations in Fig. 4.5 about the anions present or not present in **H**.

.....
 [1]

(c) The student tests the mixture from (a)(ii) for the presence of a cation.

He concludes that the cation is the ammonium ion.

Complete Table 4.1 to show the tests and observations that confirm this conclusion.

Table 4.1

test	observation
.....	remains colourless and no ppt.
warm and place damp litmus papers at the mouth of the test-tube

[2]

[Total: 10]

5 A student calculates an approximate value for the density of modelling clay.

(a) She moulds a piece of modelling clay into a block, similar to the one shown in Fig. 5.1.

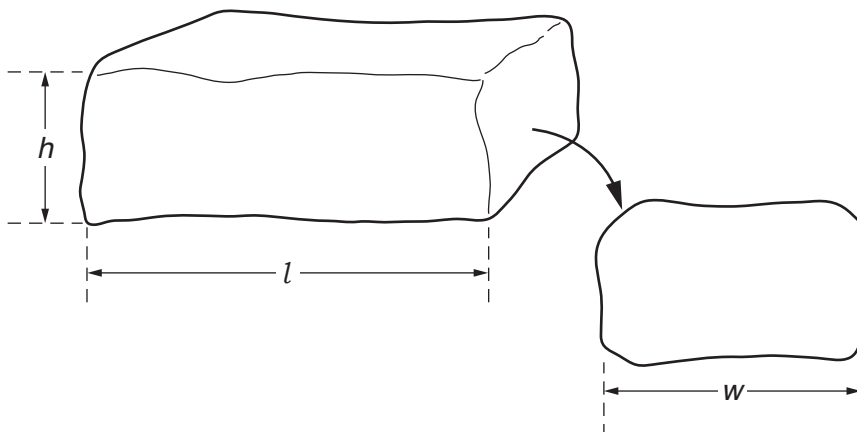

Fig. 5.1

(i) Measure and record the length l , width w and height h of the block in Fig. 5.1 to the nearest 0.1 cm.

$l = \dots\dots\dots$ cm

$w = \dots\dots\dots$ cm

$h = \dots\dots\dots$ cm
[2]

(ii) Calculate the volume V of the block. Use the equation shown.

$$V = l \times w \times h$$

$V = \dots\dots\dots$ cm³ [1]

(b) (i) State **one** reason why the value for the volume is not accurate.

.....
..... [1]

(ii) Suggest an alternative method of measuring the volume of the block that would give the student a more accurate value.

.....
..... [1]

(c) Procedure

- The student attaches a mass to a metre rule.
- She fixes the position of the mass with its centre over the 15.0 cm mark.
- She does not move this mass.
- She places a pivot under the 50.0 cm mark, as shown in Fig. 5.2.

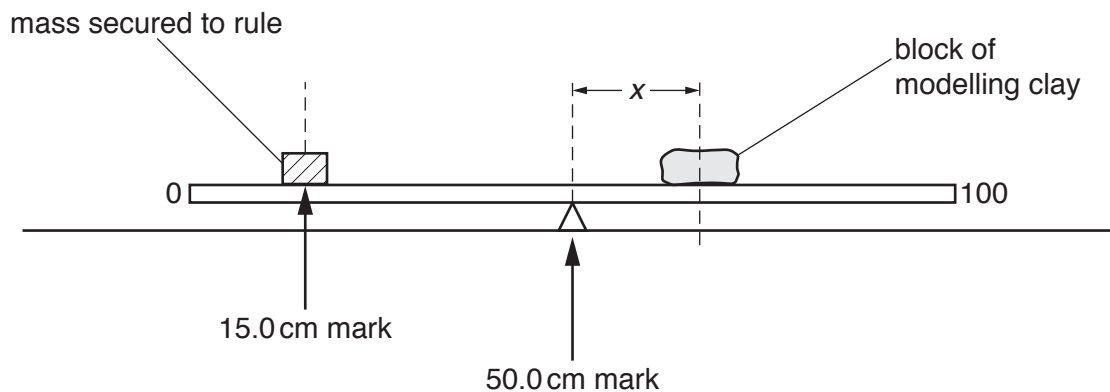
**Fig. 5.2**

- She places the block of modelling clay on the metre rule.
- She adjusts the position of the block of modelling clay until the rule is just balanced.

Fig. 5.3 shows the position of the centre of the block when the rule is balanced.

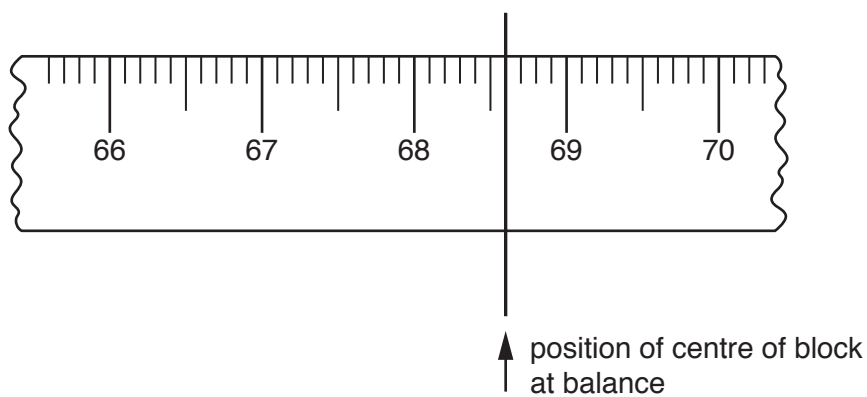
**Fig. 5.3**

- (i) Determine the distance x from the centre of the block to the 50.0 cm mark on the rule.

Show your working.

$x = \dots\dots\dots$ cm [2]

- (ii) Calculate the mass m of the block of modelling clay. Use the equation shown.

$$m = \frac{1750}{x}$$

$$m = \dots\dots\dots\text{g} \quad [1]$$

- (d) (i) State **one** reason why the value for the mass that you have calculated in (c)(ii) may not be accurate.

.....

..... [1]

- (ii) Use your answers to (a)(ii) and (c)(ii) to calculate the density d of the modelling clay. Use the equation shown.

$$d = \frac{m}{V}$$

$$d = \dots\dots\dots\text{g/cm}^3 \quad [1]$$

[Total: 10]

6 A student investigates how the resistance of a wire depends upon its length.

He sets up the circuit shown in Fig. 6.1.

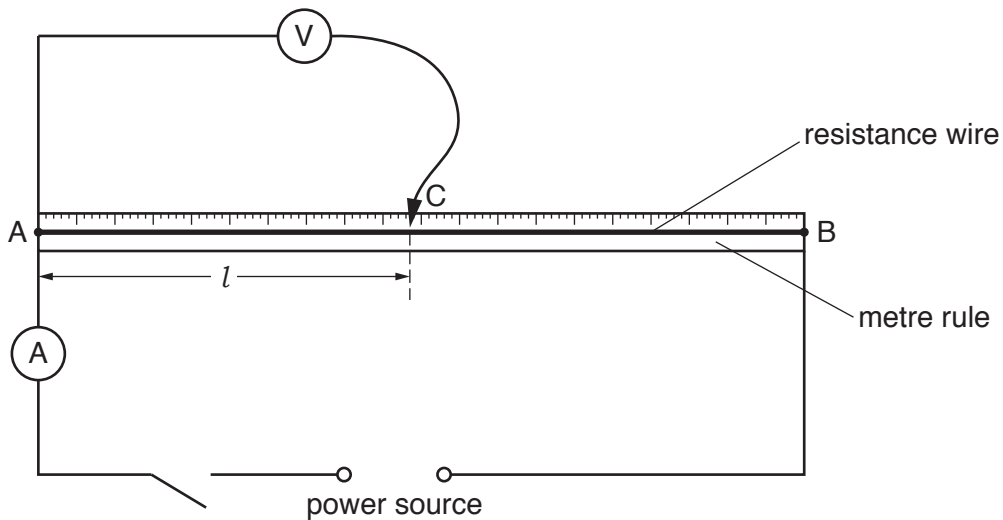

Fig. 6.1

(a) Procedure

- He closes the switch.
- He places the sliding contact C on the wire so that the length of wire $l = 10.0$ cm.
- He measures, and records in Table 6.1, the current I in the wire.
- He measures, and records in Table 6.1, the potential difference V across the wire.
- He opens the switch.

Fig. 6.2 shows the voltmeter reading for $l = 10.0$ cm.

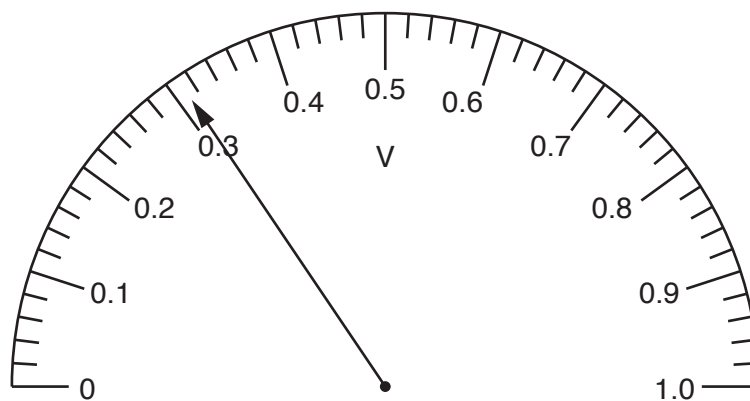

Fig. 6.2

(i) Record the value of V in Table 6.1.

Table 6.1

length l /cm	current I /A	potential difference V /V	resistance R /.....
10.0	0.36		
20.0	0.36	0.62	1.7
30.0	0.36	0.91	2.5
40.0	0.36	1.20	3.3
50.0	0.36		4.2

[1]

(ii) Complete the column heading in Table 6.1 by inserting the missing unit for resistance.

[1]

(iii) Calculate the resistance of the 10.0 cm length of the wire. Use the equation shown.

$$R = \frac{V}{I}$$

Record your answer in Table 6.1.

[1]

(b) He repeats the procedure in (a) for values of length $l = 20.0$ cm, 30.0 cm, 40.0 cm and 50.0 cm.

From the information given in Table 6.1, calculate the missing value of potential difference V when $l = 50.0$ cm. Record this value in Table 6.1.

[1]

(c) (i) Plot a graph of R (vertical axis) against l . Start your axes from the origin (0, 0).

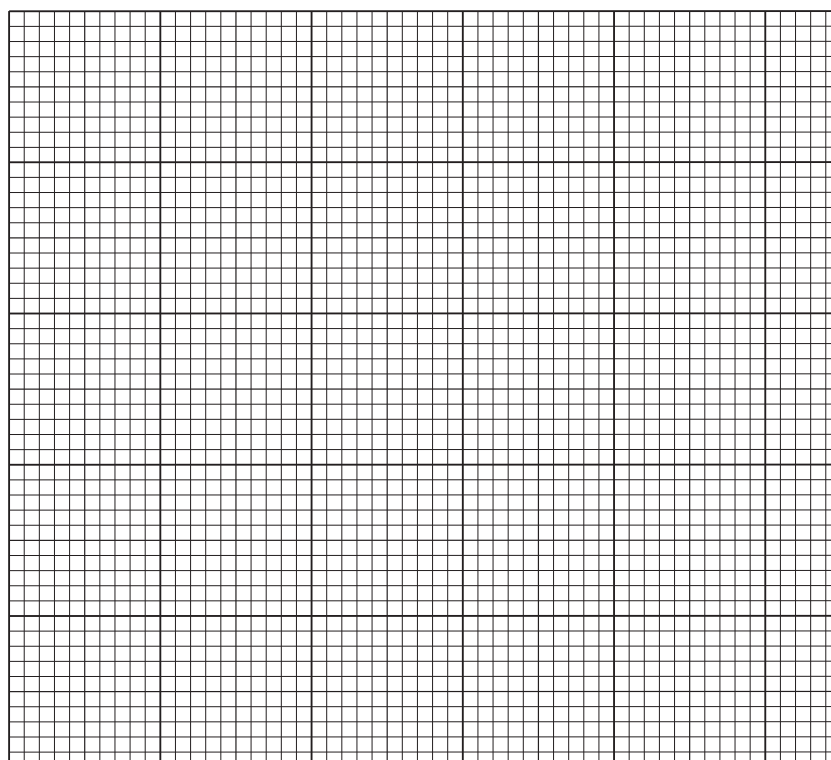

[3]

(ii) Draw the best-fit straight line on the graph in (c)(i). [1]

(d) (i) Another student states that the resistance R of the wire is directly proportional to the length l .

State whether your graph agrees with this statement.

Justify your answer by referring to the graph you have drawn.

.....
..... [1]

(ii) State how the student could improve the investigation so that she can be more confident about the conclusion in (d)(i).

.....
..... [1]

[Total: 10]

BLANK PAGE

Permission to reproduce items where third-party owned material protected by copyright is included has been sought and cleared where possible. Every reasonable effort has been made by the publisher (UCLES) to trace copyright holders, but if any items requiring clearance have unwittingly been included, the publisher will be pleased to make amends at the earliest possible opportunity.

To avoid the issue of disclosure of answer-related information to candidates, all copyright acknowledgements are reproduced online in the Cambridge Assessment International Education Copyright Acknowledgements Booklet. This is produced for each series of examinations and is freely available to download at www.cambridgeinternational.org after the live examination series.

Cambridge Assessment International Education is part of the Cambridge Assessment Group. Cambridge Assessment is the brand name of the University of Cambridge Local Examinations Syndicate (UCLES), which itself is a department of the University of Cambridge.