



UNIVERSITY OF CAMBRIDGE INTERNATIONAL EXAMINATIONS
General Certificate of Education Ordinary Level

www.PapaCambridge.com

CHEMISTRY

5070/13

Paper 1 Multiple Choice

May/June 2010

1 hour

Additional Materials: Multiple Choice Answer Sheet
 Soft clean eraser
 Soft pencil (type B or HB is recommended)

* 5 9 8 8 4 4 7 3 6 5 *

READ THESE INSTRUCTIONS FIRST

Write in soft pencil.
Do not use staples, paper clips, highlighters, glue or correction fluid.
Write your name, Centre number and candidate number on the Answer Sheet in the spaces provided unless this has been done for you.

There are **forty** questions on this paper. Answer **all** questions. For each question there are four possible answers **A, B, C** and **D**.
Choose the **one** you consider correct and record your choice in **soft pencil** on the separate Answer Sheet.

Read the instructions on the Answer Sheet very carefully.

Each correct answer will score one mark. A mark will not be deducted for a wrong answer.
Any rough working should be done in this booklet.
A copy of the Periodic Table is printed on page 16.

This document consists of **16** printed pages.



- 1 The diagram shows a simple laboratory apparatus for the preparation and collection of a gas.

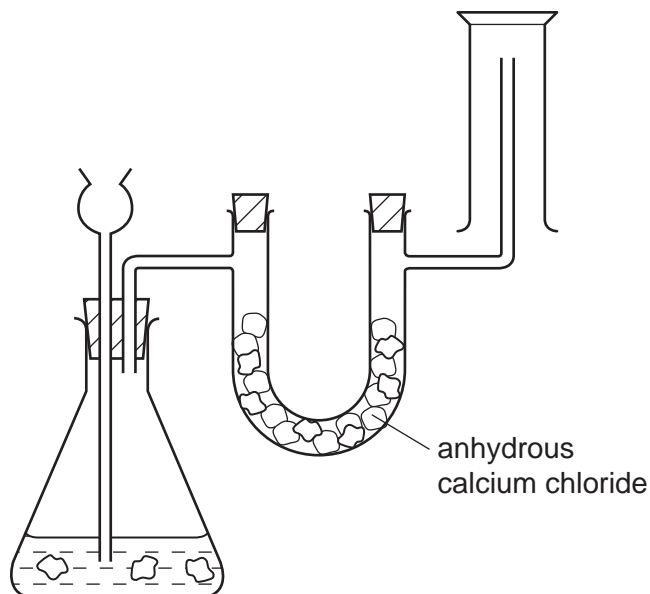

What is the gas?

- A carbon dioxide
 B chlorine
 C hydrogen
 D hydrogen chloride
- 2 What correctly describes the molecules in **very dilute** sugar solution at room temperature?

	sugar molecules	water molecules
A	close together, moving at random	close together, moving at random
B	widely separated, moving at random	close together, moving at random
C	widely separated, moving at random	close together, not moving
D	widely separated, not moving	widely separated, moving at random

- 3 A mixture containing equal volumes of two liquids that mix completely but do not react is placed in the apparatus shown and heated until the thermometer first shows a steady reading. At which position will there be the highest proportion of the liquid with the higher boiling point?

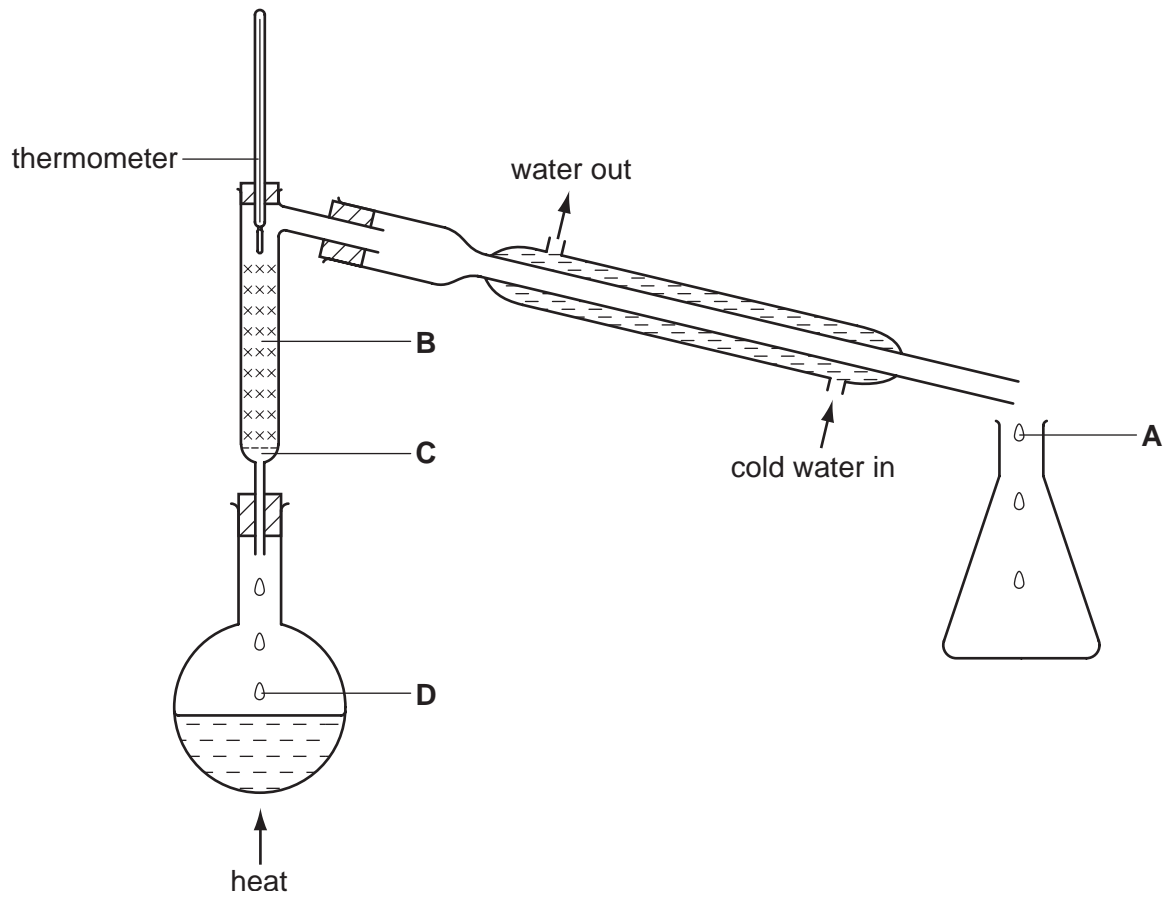

- 4 Which is an anion that is present in the solution formed when an excess of dilute hydrochloric acid is added to calcium carbonate?
- A Ca^{2+} B Cl^- C CO_3^{2-} D H^+

- 5 Which graph shows the number of electrons in the outer shell of an atom, plotted against the proton (atomic) number for the first ten elements in the Periodic Table?

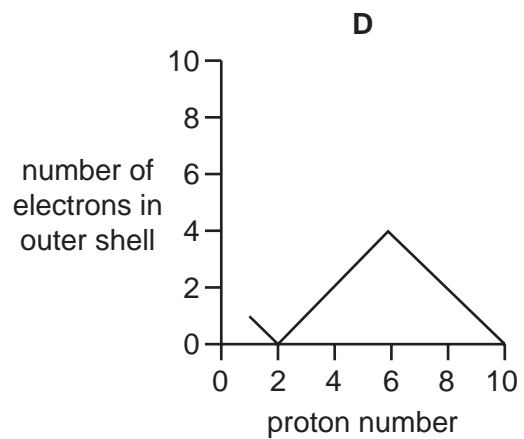
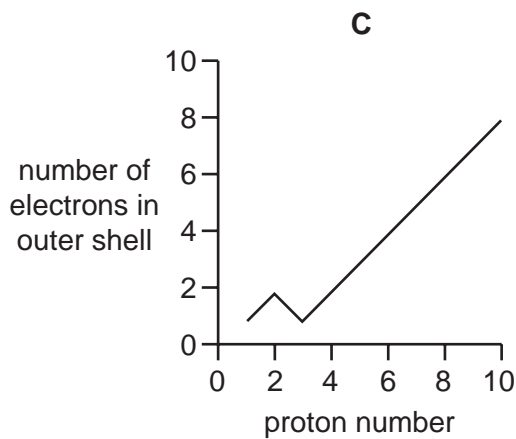
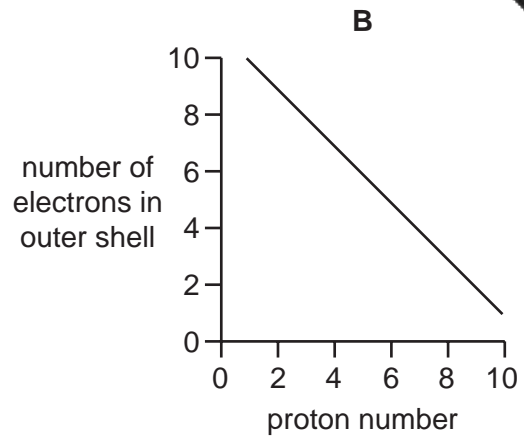
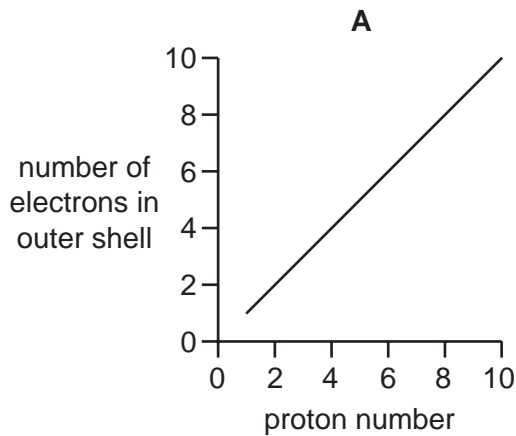

- 6 A metal consists of a lattice of positive ions in a 'sea of electrons'.

What changes, if any, take place to the electrons and positive ions in a metal wire when an electric current is passed through it?

	electrons	positive ions
A	replaced by new electrons	replaced by new ions
B	replaced by new electrons	unchanged
C	unchanged	replaced by new ions
D	unchanged	unchanged

- 7 Which pair of elements, when combined together, do **not** form a covalent compound?
- A caesium and fluorine
 B nitrogen and chlorine
 C phosphorus and fluorine
 D sulfur and chlorine
- 8 The diagram shows the structure of a covalent compound containing the element hydrogen, H, and the unknown elements X, Y and Z.

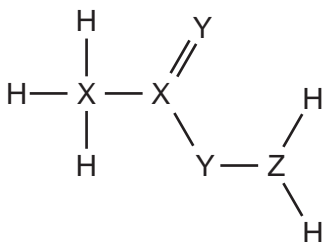

To which groups of the Periodic Table do these three elements, X, Y and Z, belong?

	X	Y	Z
A	1	5	6
B	4	5	1
C	4	6	5
D	5	1	4

- 9 Two different hydrocarbons each contain the same percentage by mass of hydrogen. It follows that they have the same
- A empirical formula.
 B number of isomers.
 C relative molecular mass.
 D structural formula.
- 10 What is the mass of one mole of carbon-12?
- A 0.012g B 0.024g C 1g D 12g

- 11 The diagram shows the electrolysis of a concentrated aqueous solution containing copper(II) ions and sodium ions.

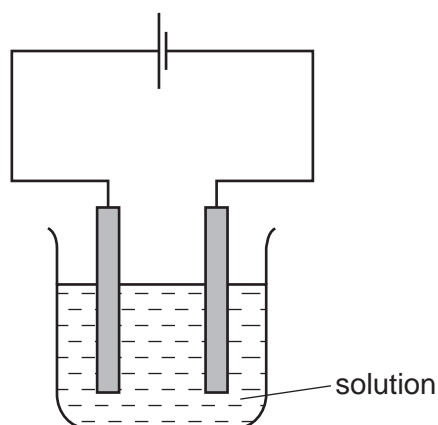

Which metal is deposited at the negative electrode and why?

	metal deposited	reason
A	copper	copper is less reactive than sodium
B	copper	copper is more reactive than hydrogen
C	sodium	copper is less reactive than hydrogen
D	sodium	copper is more reactive than sodium

- 12 The diagram shows the apparatus used to electrolyse lead(II) bromide using inert electrodes.

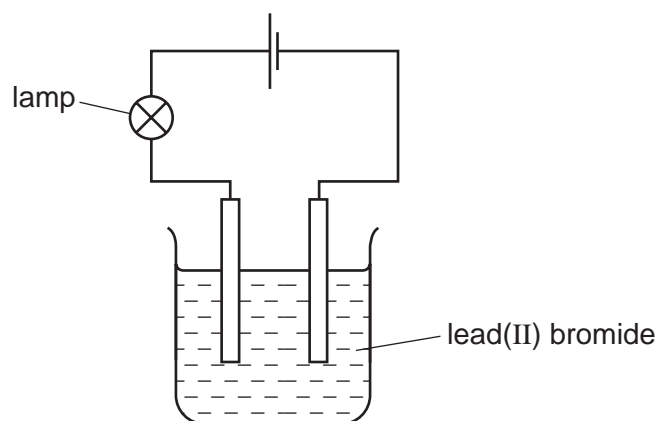

Why does the lamp light up only when the lead(II) bromide is melted?

- A** Bromine atoms in the lead(II) bromide are converted to ions when it is melted.
B Electrons flow through the lead(II) bromide when it is melted.
C The ions in lead(II) bromide are free to move only when the solid is melted.
D There are no ions in solid lead(II) bromide.

- 13 When a solution containing silver ions is added to a solution containing iron(II) ions, an equilibrium is set up.

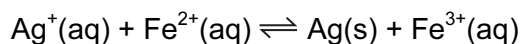

The addition of which substance would **not** affect the amount of silver precipitated?

- A $\text{Ag}^+(\text{aq})$ B $\text{Fe}^{2+}(\text{aq})$ C $\text{Fe}^{3+}(\text{aq})$ D $\text{H}_2\text{O}(\text{l})$
- 14 Which reaction does **not** involve either oxidation or reduction?

- A $\text{CH}_4(\text{g}) + 2\text{O}_2(\text{g}) \rightarrow \text{CO}_2(\text{g}) + 2\text{H}_2\text{O}(\text{g})$
 B $\text{Cu}^{2+}(\text{aq}) + \text{Zn}(\text{s}) \rightarrow \text{Cu}(\text{s}) + \text{Zn}^{2+}(\text{aq})$
 C $\text{CuO}(\text{s}) + \text{H}_2\text{SO}_4(\text{aq}) \rightarrow \text{CuSO}_4(\text{aq}) + \text{H}_2\text{O}(\text{l})$
 D $\text{Zn}(\text{s}) + \text{H}_2\text{SO}_4(\text{aq}) \rightarrow \text{ZnSO}_4(\text{aq}) + \text{H}_2(\text{g})$

- 15 A student performs two reactions.

reaction 1 10 g of magnesium ribbon with excess 2.0 mol/dm^3 dilute hydrochloric acid

reaction 2 5 g of magnesium powder with excess 2.0 mol/dm^3 dilute hydrochloric acid

In both experiments, the volume of hydrogen produced, V , is measured against time, t , and the results plotted graphically.

Which set of graphs is correct?

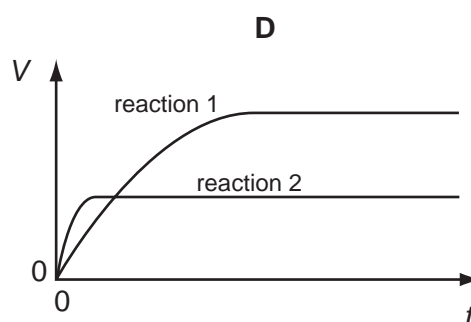
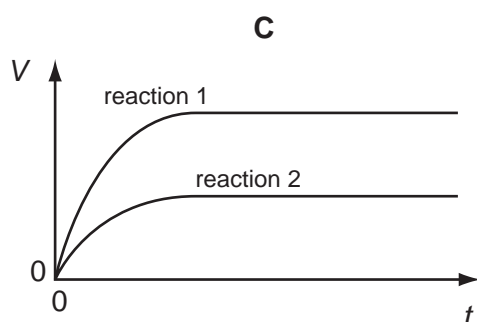
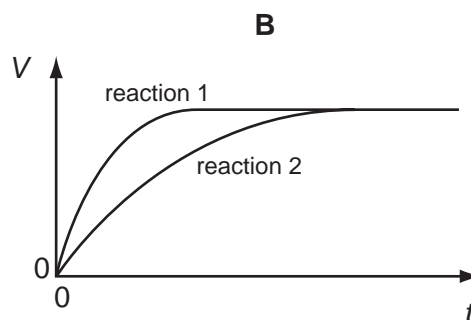
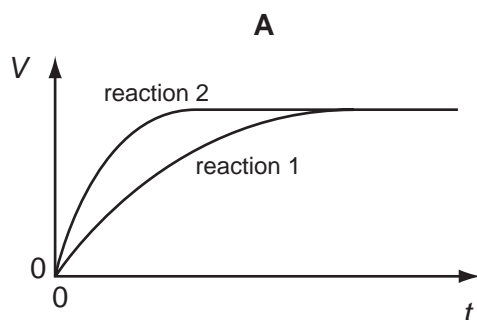

16 Which statement about catalysts is correct for a typical equilibrium reaction?

- A A catalyst can be either an inorganic or an organic species.
- B A catalyst does not take part in the reaction.
- C A catalyst only speeds up the forward reaction.
- D A catalyst provides the energy required to start a reaction.

17 Which pair of compounds could be used in the preparation of calcium sulfate?

- A calcium carbonate and sodium sulfate
- B calcium chloride and ammonium sulfate
- C calcium hydroxide and barium sulfate
- D calcium nitrate and lead(II) sulfate

18 Titration of an acid against a base is a method often used in the preparation of salts.

Which properties of the acid, the base and the salt are required if this method is to be used?

	acid	base	salt
A	insoluble	insoluble	insoluble
B	soluble	insoluble	insoluble
C	soluble	soluble	insoluble
D	soluble	soluble	soluble

19 A metal reacts with dilute hydrochloric acid to produce a gas.

What is used to identify this gas?

- A a glowing splint
- B a lighted splint
- C damp blue litmus paper
- D limewater

- 20 The oxide of an element X increases the rate of decomposition of hydrogen peroxide. In the reaction the oxide of X is unchanged.

Which details are those of X?

	proton number	mass number
A	18	40
B	20	40
C	25	55
D	82	207

- 21 Which element is sodium?

	melting point in °C	electrical conduction	density in g/cm ³
A	1535	good	7.86
B	1083	good	8.92
C	113	poor	2.07
D	98	good	0.97

- 22 Which row shows the correct number of protons and electrons in the ion of an element in Group II of the Periodic Table?

	number of protons	number of electrons
A	9	10
B	12	10
C	14	14
D	16	18

23 The diagram shows part of the Periodic Table.

													P	
	Q												R	S
	T													

Which pair of letters represents elements that are in the same period?

- A** P and R **B** P and S **C** Q and T **D** R and S

24 From your knowledge of the manufacture of both aluminium and iron, what is the order of chemical reactivity of aluminium, carbon and iron towards oxygen?

	most reactive	→	least reactive
A	aluminium		carbon iron
B	aluminium		iron carbon
C	carbon		aluminium iron
D	carbon		iron aluminium

25 An alloy of copper and zinc is added to an excess of dilute hydrochloric acid.

Which observations are correct?

	residue	filtrate
A	grey	blue solution
B	none	blue solution
C	none	colourless solution
D	red-brown	colourless solution

26 In the extraction of iron, carbon monoxide acts as

- A** a catalyst.
B an inert gas.
C an oxidising agent.
D a reducing agent.

27 Which substances react together to give hydrogen?

- A calcium oxide and water
- B copper and dilute sulfuric acid
- C copper and steam
- D magnesium and steam

28 The diagram shows apparatus for measuring the volume of hydrogen given off when an excess of dilute hydrochloric acid is added to powdered metal. The volume of gas is measured at room temperature and pressure.

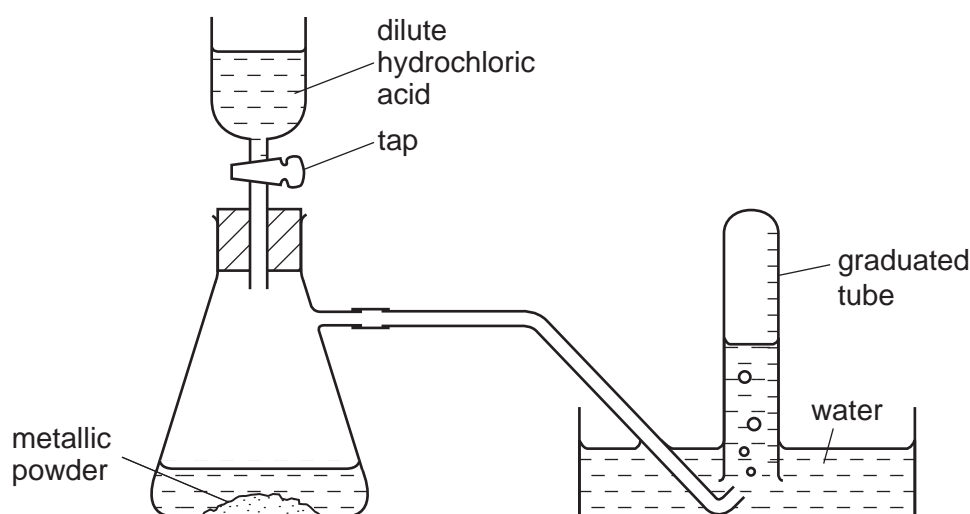

The experiment is carried out three times, using the same mass of powder each time but with different powders:

- pure magnesium
- pure zinc
- a mixture of magnesium and zinc

Which powder gives the greatest volume of hydrogen and which the least volume?

	greatest volume of H ₂	least volume of H ₂
A	magnesium	zinc
B	magnesium	the mixture
C	zinc	magnesium
D	zinc	the mixture

29 Which gas burns in air to form only one product?

- A ammonia
- B carbon monoxide
- C hydrogen chloride
- D methane

30 Why is carbon used in the purification of drinking water?

- A It desalinates the water.
- B It disinfects the water.
- C It filters out solids.
- D It removes tastes and odours from the water.

31 Which compound will **not** produce ammonia when heated with ammonium sulfate?

- A calcium oxide
- B magnesium oxide
- C sodium hydroxide
- D sulfuric acid

32 These reactions are used in the manufacture of sulfuric acid.

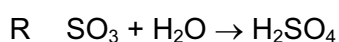
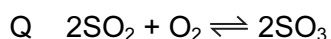
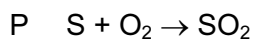

Which reactions are speeded up by using a catalyst?

- A P only B Q only C R only D Q and R

33 Which substances will burn in air and give carbon dioxide amongst the combustion products?

- 1 calcium carbonate
- 2 ethane
- 3 ethanol
- 4 methanol

- A 1 and 2 only B 2 and 3 only C 1, 2 and 3 only D 2, 3 and 4 only

- 34 The two statements are about the fractional distillation of crude oil. The statements may or may not be correct. They may or may not be linked.

statement 1 Fractional distillation is used to separate crude oil into useful fractions.

statement 2 The fractions with lower boiling points are found at the top of the fractionating column.

What is correct about these two statements?

- A** Both statements are correct and statement 2 explains statement 1.
B Both statements are correct but statement 2 does not explain statement 1.
C Statement 1 is correct but statement 2 is incorrect.
D Statement 1 is incorrect but statement 2 is correct.
- 35 When butanol, represented by C_4H_wOH , burns in air, carbon dioxide and water are formed.

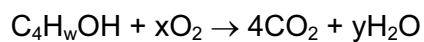

Which values of w, x and y balance the equation?

	w	x	y
A	8	6	4
B	9	6	4
C	9	6	5
D	10	7	5

- 36 An aqueous solution of a compound of formula $C_2H_4O_2$ reacts with sodium carbonate to form sodium acetate and carbon dioxide.

What is the structural formula of the compound?

A

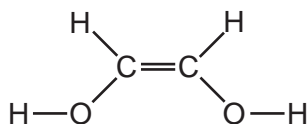

B

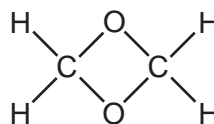

C

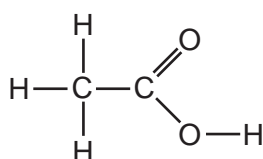

D

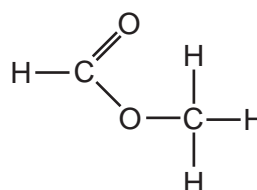

- 37 How does the number of carbon, hydrogen and oxygen atoms in an ester differ from the total number of carbon, hydrogen and oxygen atoms in the alcohol and carboxylic acid from which the compound was derived?

	carbon atoms	hydrogen atoms	oxygen atoms
A	less	less	less
B	less	same	less
C	same	less	less
D	same	same	same

- 38 The list shows three chemical reactions.

- 1 combustion of ethanol
- 2 fermentation of glucose
- 3 reaction of ethanol with ethanoic acid to give an ester

In which reactions is water a product?

- A** 1 and 2 only **B** 1 and 3 only **C** 2 and 3 only **D** 1, 2 and 3

39 The diagram shows a reaction scheme.

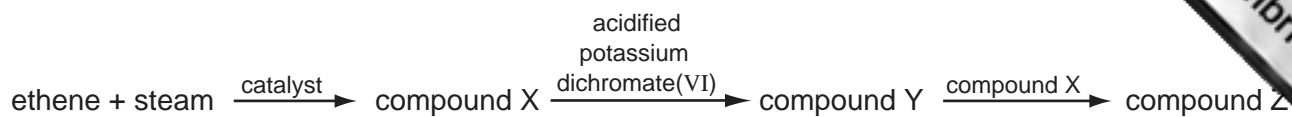

What is the final compound, Z?

- A a carboxylic acid
 - B an alcohol
 - C an alkene
 - D an ester
- 40 The macromolecules of proteins, fats and carbohydrates can all be broken down into their simple units by a similar process.

What is the process called?

- A esterification
- B hydrolysis
- C oxidation
- D reduction

DATA SHEET
The Periodic Table of the Elements

		Group																																																																																																										
I	II	III	IV	V	VI	VII	O																																																																																																					
7 Li Lithium 3	9 Be Beryllium 4	1 H Hydrogen 1	11 B Boron 5	12 C Carbon 6	14 N Nitrogen 7	16 O Oxygen 8	19 F Fluorine 9	20 Ne Neon 10	23 Na Sodium 11	24 Mg Magnesium 12	27 Al Aluminium 13	28 Si Silicon 14	31 P Phosphorus 15	32 S Sulfur 16	35.5 Cl Chlorine 17	40 Ar Argon 18	39 K Potassium 19	40 Ca Calcium 20	45 Sc Scandium 21	48 Ti Titanium 22	51 V Vanadium 23	52 Cr Chromium 24	55 Mn Manganese 25	56 Fe Iron 26	59 Co Cobalt 27	59 Ni Nickel 28	64 Cu Copper 29	65 Zn Zinc 30	70 Ga Gallium 31	73 Ge Germanium 32	75 As Arsenic 33	79 Se Selenium 34	80 Br Bromine 35	84 Kr Krypton 36	85 Rb Rubidium 37	88 Sr Strontium 38	89 Y Yttrium 39	91 Zr Zirconium 40	93 Nb Niobium 41	96 Mo Molybdenum 42	101 Ru Ruthenium 44	106 Pd Palladium 46	112 Cd Cadmium 48	115 In Indium 49	119 Sn Tin 50	122 Sb Antimony 51	128 Te Tellurium 52	131 Xe Xenon 54	133 Cs Caesium 55	137 Ba Barium 56	139 La Lanthanum 57	178 Hf Hafnium 72	181 Ta Tantalum 73	184 W Tungsten 74	186 Re Rhenium 75	190 Os Osmium 76	192 Ir Iridium 77	195 Pt Platinum 78	197 Au Gold 79	201 Hg Mercury 80	204 Tl Thallium 81	207 Pb Lead 82	209 Bi Bismuth 83	210 Po Polonium 84	210 At Astatine 85	226 Ra Radium 88	227 Ac Actinium 89	227 Fr Francium 87	232 Th Thorium 90	232 Pa Protactinium 91	238 U Uranium 92	238 Np Neptunium 93	238 Pu Plutonium 94	238 Am Americium 95	238 Cm Curium 96	238 Bk Berkelium 97	238 Cf Californium 98	238 Es Einsteinium 99	238 Fm Fermium 100	238 Md Mendelevium 101	238 No Nobelium 102	238 Lr Lawrencium 103	140 Ce Cerium 58	141 Pr Praseodymium 59	144 Nd Neodymium 60	147 Pm Promethium 61	150 Sm Samarium 62	152 Eu Europium 63	157 Gd Gadolinium 64	162 Dy Dysprosium 66	165 Ho Holmium 67	167 Er Erbium 68	169 Tm Thulium 69	173 Yb Ytterbium 70	175 Lu Lutetium 71	140 Ce Cerium 58	141 Pr Praseodymium 59	144 Nd Neodymium 60	147 Pm Promethium 61	150 Sm Samarium 62	152 Eu Europium 63	157 Gd Gadolinium 64	162 Dy Dysprosium 66	165 Ho Holmium 67	167 Er Erbium 68	169 Tm Thulium 69	173 Yb Ytterbium 70	175 Lu Lutetium 71

*58-71 Lanthanoid series
†90-103 Actinoid series

a	X	a = relative atomic mass
b	X	X = atomic symbol
		b = proton (atomic) number

The volume of one mole of any gas is 24 dm³ at room temperature and pressure (r.t.p.).

Permission to reproduce items where third-party owned material protected by copyright is included has been sought and cleared where possible. Every reasonable effort has been made by the publisher (UCLES) to trace copyright holders, but if any items requiring clearance have unwittingly been included, the publisher will be pleased to make amends at the earliest possible opportunity.