



UNIVERSITY OF CAMBRIDGE INTERNATIONAL EXAMINATIONS
General Certificate of Education Ordinary Level

CANDIDATE
NAME

CENTRE
NUMBER

--	--	--	--	--

CANDIDATE
NUMBER

--	--	--	--



HUMAN AND SOCIAL BIOLOGY

5096/22

Paper 2

October/November 2010

2 hours

Candidates answer on the Question Paper.

No Additional Materials are required.

READ THESE INSTRUCTIONS FIRST

Write your Centre number, candidate number and name on all the work you hand in.
Write in dark blue or black pen.
You may use a pencil for any diagrams, graphs or rough working.
Do not use staples, paper clips, highlighters, glue or correction fluid.
DO NOT WRITE IN ANY BARCODES.

Section A

Answer **all** questions.
Write your answers in the spaces provided on the Question Paper.
You are advised to spend no longer than 1 hour on Section A.

Section B

Answer **all** the questions, including questions 8, 9 and 10 **Either** or 10 **Or**.
Write your answers in the spaces provided on the Question Paper.
Write an **E** (for Either) or an **O** (for Or) next to the number 10 in the
Examiner's grid to indicate which question you have answered.

The number of marks is given in brackets [] at the end of each question
or part question.

For Examiner's Use	
1	
2	
3	
4	
5	
6	
7	
Section A sub-total	
8	
9	
10	
Total	

This document consists of **15** printed pages and **1** blank page.



Section A

Answer **all** questions in this section.

Write your answers in the spaces provided.

- 1 Fig. 1.1 represents several different types of molecules in solution, separated by a membrane.

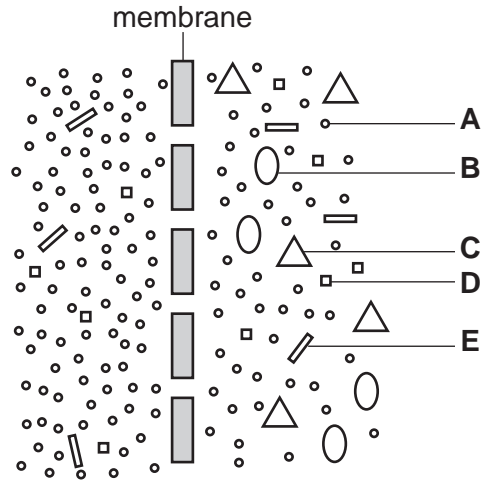

Fig.1.1

- (a) State which letter represents a water molecule. [1]
 (b) State the type of membrane shown in Fig. 1.1. [1]
 (c) Explain the processes by which molecules move through the membrane.

.....

 [6]

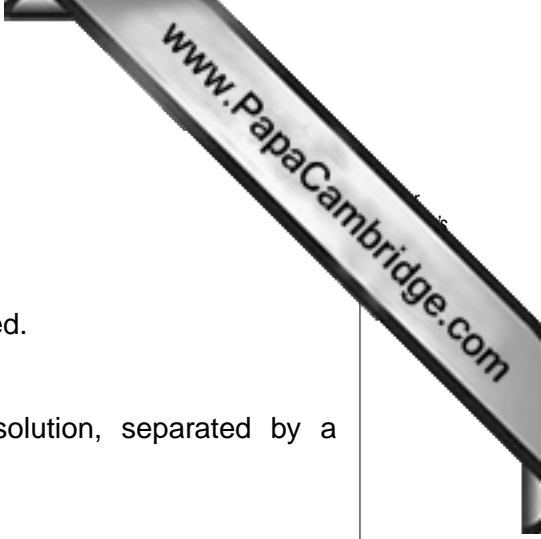

Fig. 1.2 shows what happens during filtration in the glomerulus of a kidney.

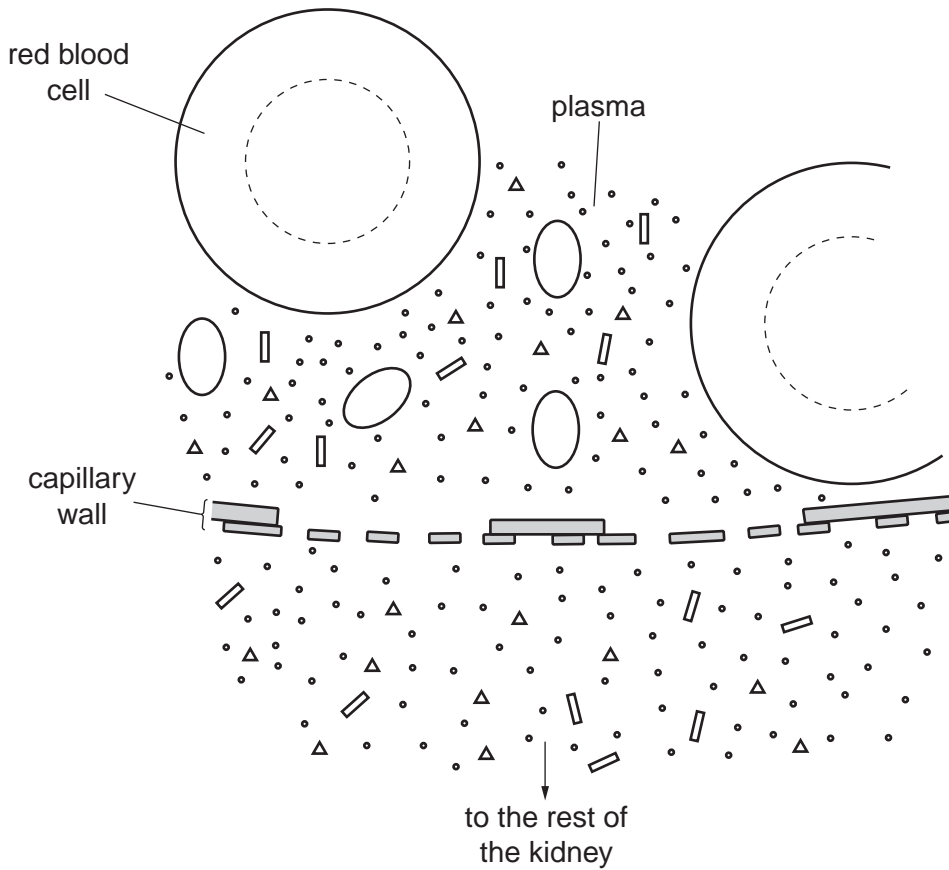

Fig. 1.2

(d) Name the molecules that pass out of the blood plasma.

.....

.....

.....

.....

.....

..... [4]

(e) Explain how filtration differs from the processes explained in (c).

.....

.....

.....

.....

.....

..... [3]

- (f) Explain what happens to molecules in the filtrate before urine leaves the kidney.

.....

.....

.....

.....

.....

.....

.....

.....

.....

.....

.....

.....

..... [5]

[Total: 20]

2 Fig. 2.1 shows a person's alimentary canal.

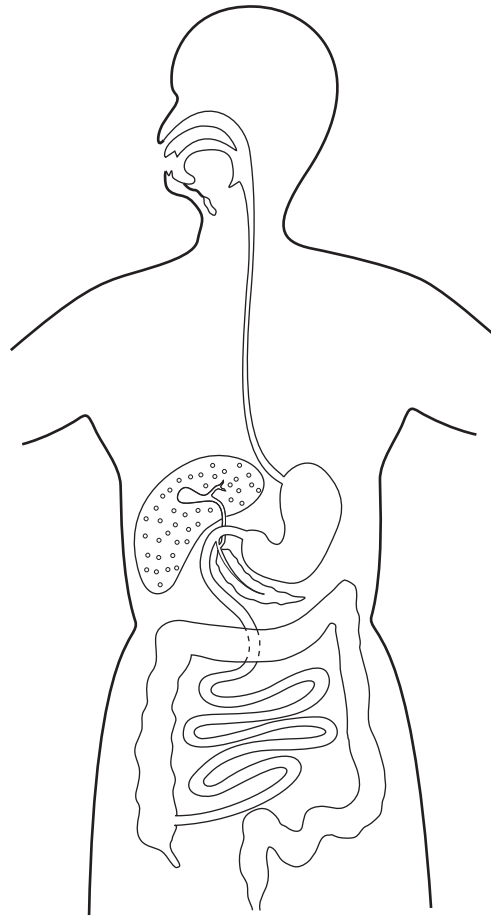

Fig. 2.1

- (a) On Fig. 2.1, draw in and label the diaphragm. [1]
- (b) Using a line labelled **X**, show where fat is emulsified. [1]
- (c) Describe the pathway taken by a digested fat molecule from the intestines to the heart.

.....

.....

.....

..... [3]

[Total: 5]

- 3 Fig. 3.1 shows a human forearm and the muscles that bring about its movement.

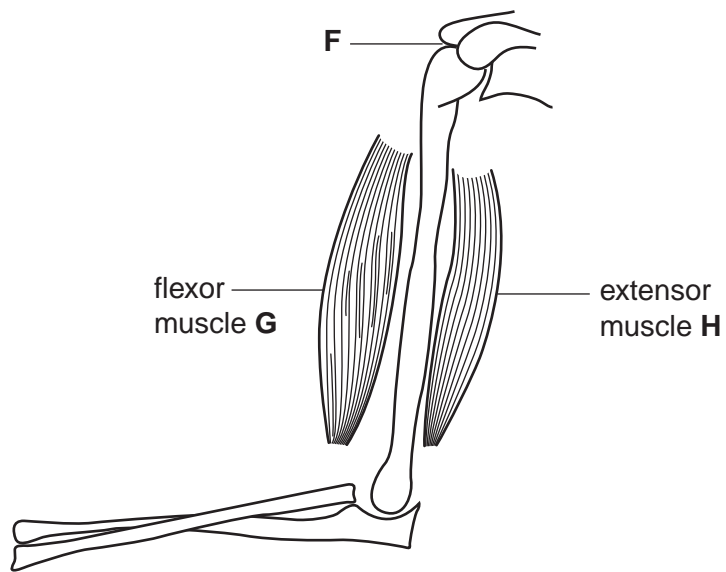

Fig. 3.1

- (a) Identify the type of joint found at **F**. [1]
- (b) Draw, on Fig. 3.1, tendons to show
- (i) the insertion of muscle **G**,
- (ii) the origin of muscle **H**. [2]

(c) Fig. 3.2 shows the leg muscles of a person sitting on a chair.

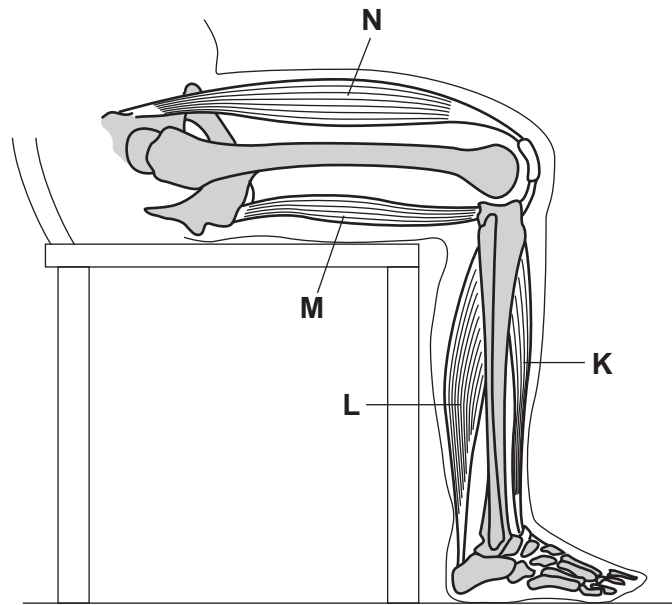

Fig. 3.2

Using the information in Fig. 3.2, suggest which of the muscles, **K**, **L**, **M** or **N** is the flexor for the knee joint. Explain your answer.

muscle [1]

explanation [1]

[Total: 5]

- 4 Fig. 4.1 shows a human sperm cell.

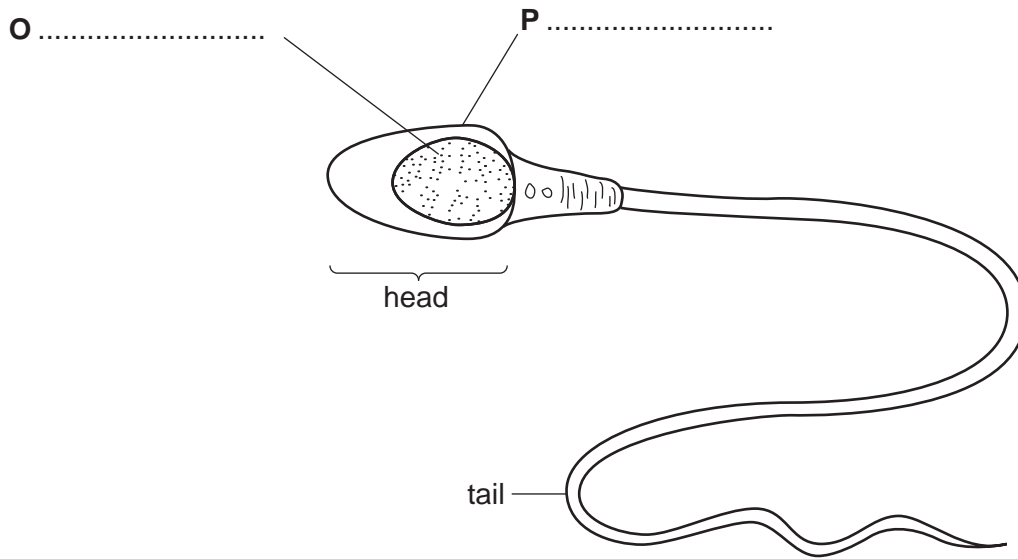

Fig. 4.1

- (a) On Fig. 4.1, label the structures **O** and **P**. [2]

- (b) Explain what is meant by the term *chromosome*.

.....
 [2]

- (c) Using the symbols **X** and **Y**, draw a diagram to show how sex is inherited in humans.

5 The concentration of nitrate ions in the soil was measured before, during and after the growing of a crop. The results are shown in Fig. 5.1.

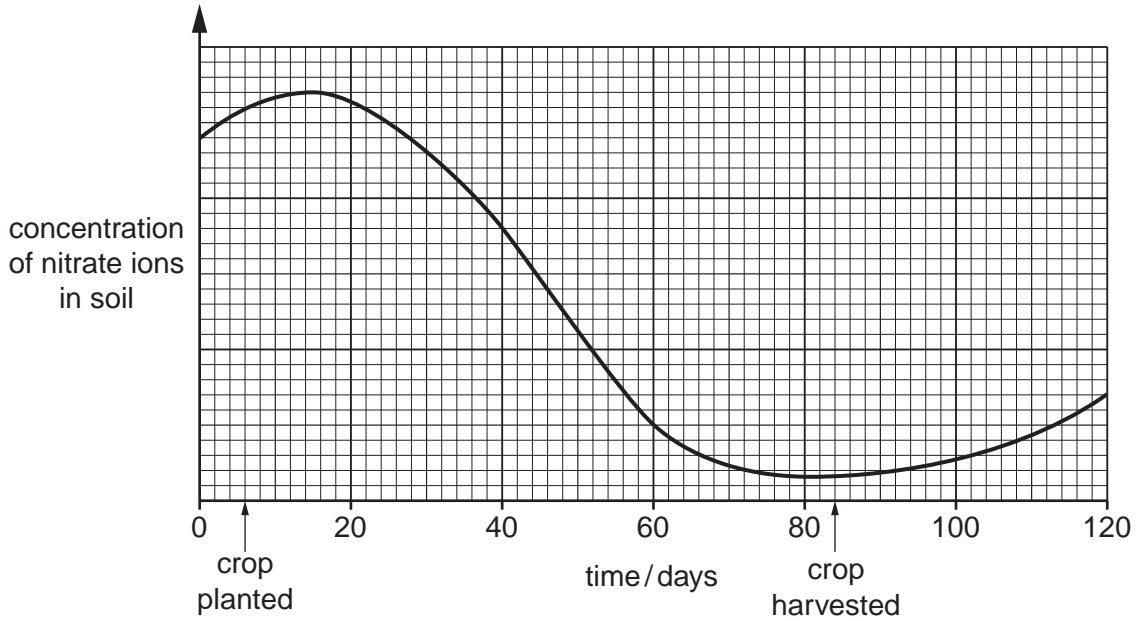

Fig. 5.1

(a) State the name of the nutrient cycle in which nitrate ions are involved.

..... [1]

(b) Outline how nitrate ions are used by the crop plant.

.....
..... [2]

(c) Explain what is happening in the soil between time 0 and the planting of the crop to increase the concentration of nitrate ions in the soil.

.....
.....
.....
.....
.....
.....
.....
.....
.....
.....
..... [4]

[Total: 7]

6 The diets of two twelve-year-old girls from two countries in different parts of the world were analysed. The results are shown in Fig. 6.1.



Fig. 6.1

(a) Using information from Fig. 6.1, complete the table to compare the diet for the girl in country Q with that of the girl in country R. In each box, write *more* or *less* or *the same*.

	meat, eggs, fish	cereals	dairy products	sugars, sweets	vegetables, fruit
diet for girl in country Q					

[1]

(b) Most of the daily energy intake is provided by carbohydrates and fats. Select **one** of the food groups from Fig. 6.1 that would provide a good source of

(i) carbohydrates,

(ii) fats. [2]

(c) Suggest why the girl from country Q is more likely than the girl from country R to suffer from

(i) poor wound healing (scurvy),

 [2]

(ii) constipation.

 [3]

7 Fig. 7.1 shows a neurone.

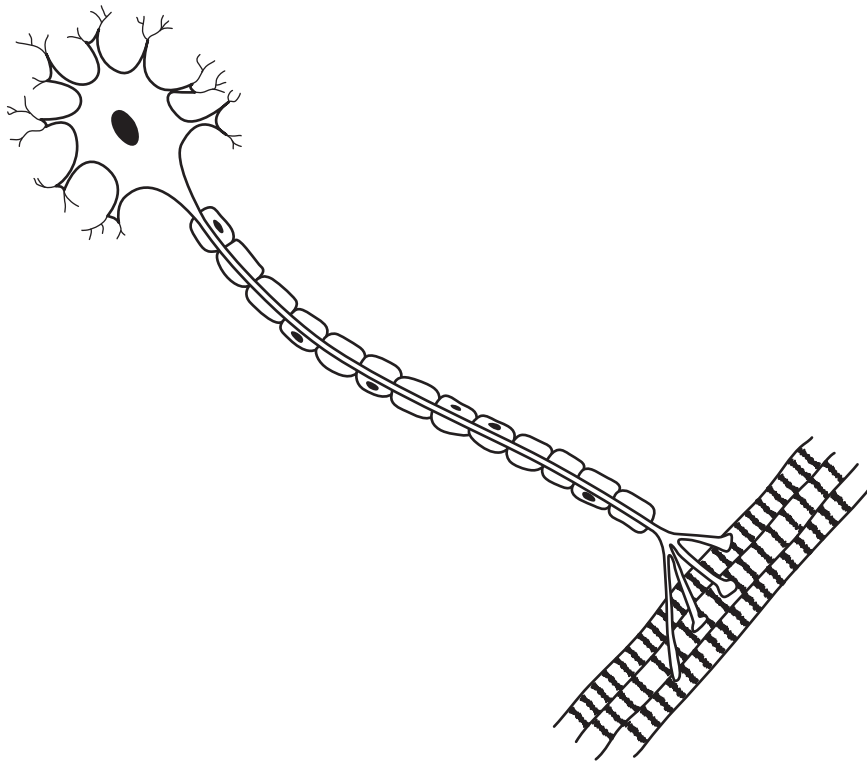

Fig. 7.1

(a) State the difference between a neurone and a nerve.

.....
..... [1]

(b) State which type of neurone is shown in Fig. 7.1 and explain your answer.

type of neurone
explanation
..... [2]

[Total: 3]

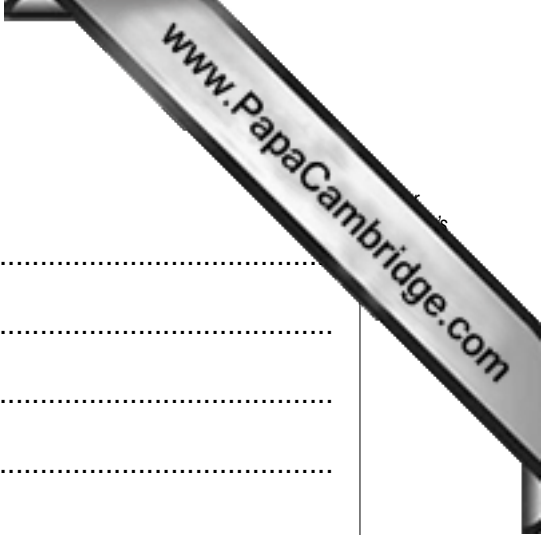

9 (a) Distinguish between *breathing* and *respiration*.

.....
.....
.....
.....
.....
.....
.....
..... [8]

(b) (i) Describe how mouth-to-mouth resuscitation is carried out.

.....
.....
.....
.....
.....
.....
.....
.....

(ii) State the circumstances in which mouth-to-mouth resuscitation should be given, and explain its value.

.....
.....
.....
.....
.....
..... [7]

