

Centre Number	Candidate Number	Name
---------------	------------------	------

UNIVERSITY OF CAMBRIDGE INTERNATIONAL EXAMINATIONS
General Certificate of Education Ordinary Level

PHYSICS

5054/02

Paper 2 Theory

October/November 2006

1 hour 45 minutes

Candidates answer on the Question Paper.
Additional Materials: Answer Booklet/Paper.

READ THESE INSTRUCTIONS FIRST

Write your Centre number, candidate number and name on all the work you hand in.
Write in dark blue or black pen.
You may use a soft pencil for any diagrams, graphs or rough working.
Do not use staples, paper clips, highlighters, glue or correction fluid.

Section A

Answer **all** questions.

Write your answers in the spaces provided on the Question Paper.

Section B

Answer any **two** questions.

Write your answers on the separate answer paper provided.

At the end of the examination, fasten the separate answer paper securely to the Question Paper.
The number of marks is given in brackets [] at the end of each question or part question.

For Examiner's Use	
Section A	
Q9	
Q10	
Q11	
Total	

Section A

Answer **all** the questions in this section.

- 1 Fig. 1.1 represents the motion of a car along a straight road. As the car approaches a small town, it slows down. The car travels at a constant speed from the start of the town to the end of the town. After passing through the town, the car speeds up.

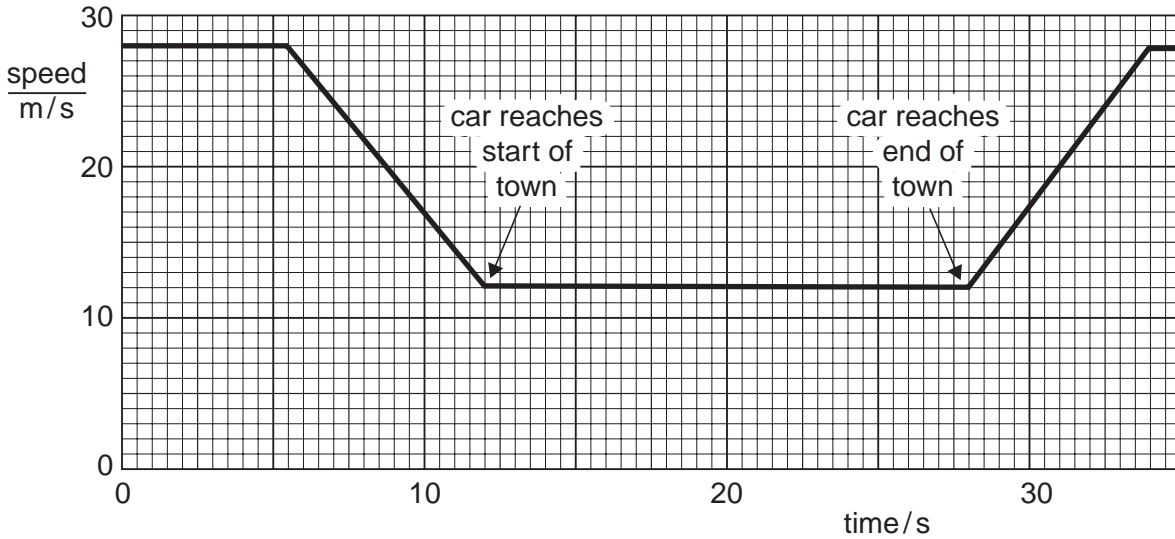

Fig. 1.1

- (a) (i) Determine the speed of the car in the town.

speed = [1]

- (ii) Determine the time taken by the car to pass through the town.

time taken = [1]

- (iii) Calculate the distance travelled by the car in the town.

distance = [1]

- (b) The car accelerates after passing through the town.

Calculate the acceleration. Give the unit of your answer.

acceleration = [3]

2 Fig. 2.1 shows apparatus that demonstrates how a coin and a piece of paper fall from

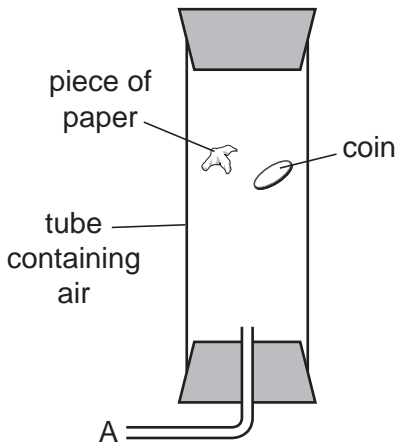

Fig. 2.1

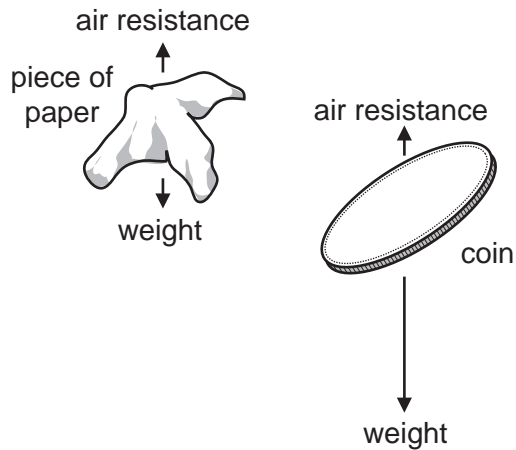

Fig. 2.2

At the positions shown in Fig. 2.1, the coin and paper are falling through air in the tube. The forces on them are shown in Fig. 2.2. The length of an arrow indicates the size of each force.

(a) State the initial value of the acceleration of the coin as it falls.

..... [1]

(b) Explain how Fig. 2.2 shows that

(i) the paper falls with constant speed,

.....

(ii) the coin accelerates.

.....

[3]

(c) A vacuum pump is connected to A and the air in the tube is removed.

The coin and paper fall differently in a vacuum from the way they fall in air.

State two of these differences.

1.

2.

- 3 Three horizontal rods are placed with one end just above a Bunsen flame. The other end of each rod is coated with wax, as shown in Fig. 3.1.

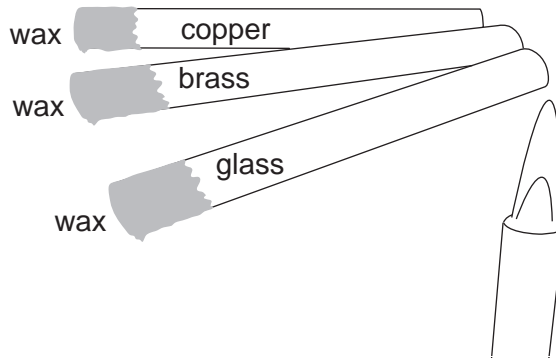

Fig. 3.1

- (a) Describe how you would use the apparatus to discover which rod is the best conductor of heat.

.....

.....

.....

.....

.....

..... [2]

- (b) Two metal teapots are identical except that one is black on the outside and the other is white on the outside, as shown in Fig. 3.2.

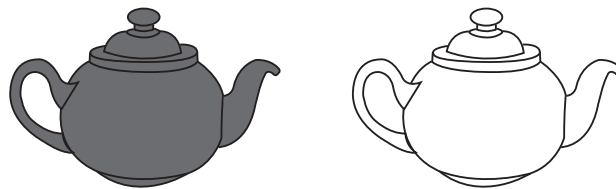

Fig. 3.2

The teapots each contain the same amount of hot water.

State and explain which teapot will cool down more quickly.

.....

.....

.....

.....

.....

5 Fig. 5.1 shows a magnet, two compasses and two nails.

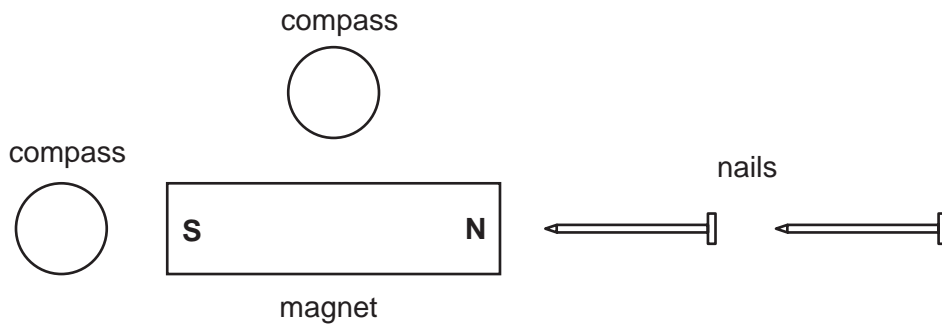

Fig. 5.1

(a) On Fig. 5.1, draw an arrow in each compass to show the direction of the magnetic field at the two positions. [2]

(b) The magnet causes the nails to become magnetised by induction. Both ends of each nail become magnetic poles.

On Fig. 5.1, mark an N or an S at each end of the two nails to show the magnetic poles. [2]

(c) When the magnet is removed, the nails are still magnetised.

Describe with the aid of a diagram how the nails can be demagnetised.

.....

.....

.....

.....

.....

..... [2]

- 6 Fig. 6.1 shows a device used to generate electricity. Water entering at the top turns the wheel. A generator connected to the wheel produces electric current.

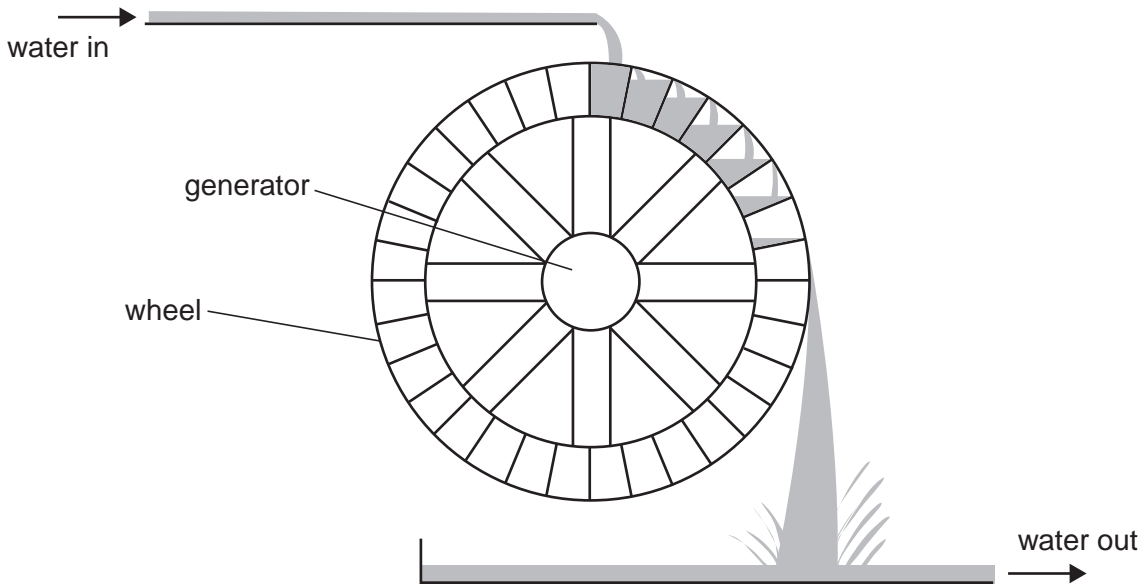

Fig. 6.1

- (a) State the two main energy changes that take place in this device as water starts to flow.

1.
2. [2]

- (b) The change in the potential energy of the water every second is 2000 J. The electrical energy output is 1200 J every second.

Calculate the efficiency of the process.

efficiency = [2]

- (c) State two ways in which the device wastes energy.

1.
2. [2]

7 Fig. 7.1 shows one way to demonstrate an electrical effect.

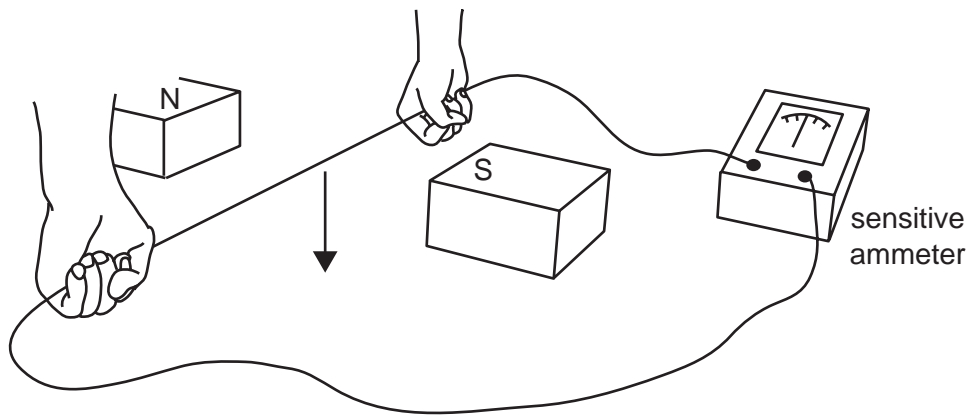

Fig. 7.1

As the wire is moved downwards between the magnetic poles, the needle of the ammeter deflects to the right.

(a) State the name of this electrical effect.

..... [1]

(b) State what happens to the needle of the ammeter when the wire is moved upwards between the magnetic poles.

.....
..... [1]

(c) State and explain what happens when the wire is held stationary between the magnetic poles.

.....
.....
.....
.....
..... [2]

- 8 Fig. 8.1 shows an electrical circuit using two resistors.

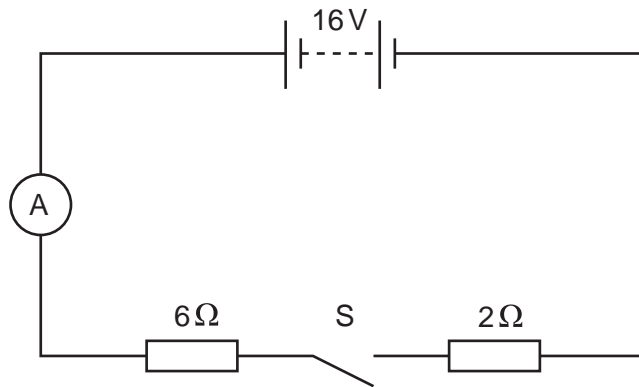

Fig. 8.1

- (a) The switch S is open and the ammeter reading is zero.

State the value of the potential difference across the $6\ \Omega$ resistor.

potential difference = [1]

- (b) Switch S is now closed.

- (i) State the value of the total resistance of the circuit.

resistance = [1]

- (ii) Calculate the current in the ammeter. State clearly the formula that you use.

current = [2]

- (iii) Calculate the potential difference across the $6\ \Omega$ resistor.

p.d. = [2]

Section B

Answer **two** questions from this section.

Use the separate answer sheets available from the Supervisor.

- 9 Fig. 9.1 shows a thin sheet of metal suspended from a hole in one corner at A. The weight of the metal is 0.10 N and the centre of mass is at B. The diagram is drawn full scale.

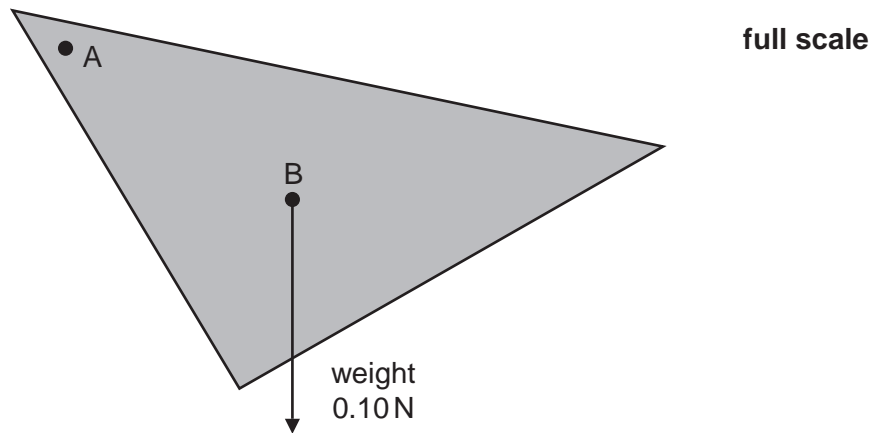

Fig. 9.1

- (a) Describe in detail how you would experimentally determine the position of the centre of mass of the sheet of metal. [6]
- (b) The sheet turns because of the moment of the weight about point A.
- (i) Define what is meant by the *moment of a force*. [2]
- (ii) Using a distance measured on Fig. 9.1, calculate the moment of the weight about point A. State clearly which distance you measured and give the unit of your final answer. [3]
- (c) Fig. 9.2 and Fig. 9.3 show a thick piece of wood with one corner on a table.

Fig. 9.4 shows the same piece of wood balanced on the table. B is the centre of mass.

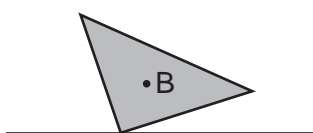

Fig. 9.2

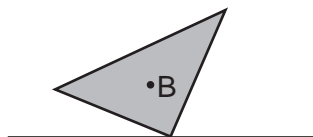

Fig. 9.3

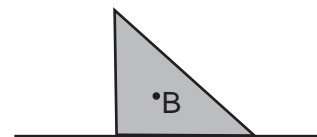

Fig. 9.4

- (i) Explain why in Fig. 9.2 the piece of wood falls to the right and in Fig. 9.3 it falls to the left. [2]
- (ii) Explain why the piece of wood in Fig. 9.4 does not fall over. [1]
- (iii) Suggest how the thickness of the wood in Fig. 9.4 affects its stability. [1]

- 10 Fig. 10.1 shows a cable containing three wires coloured brown, blue and yellow/green. The cable is connected to a mains plug with the cover removed.

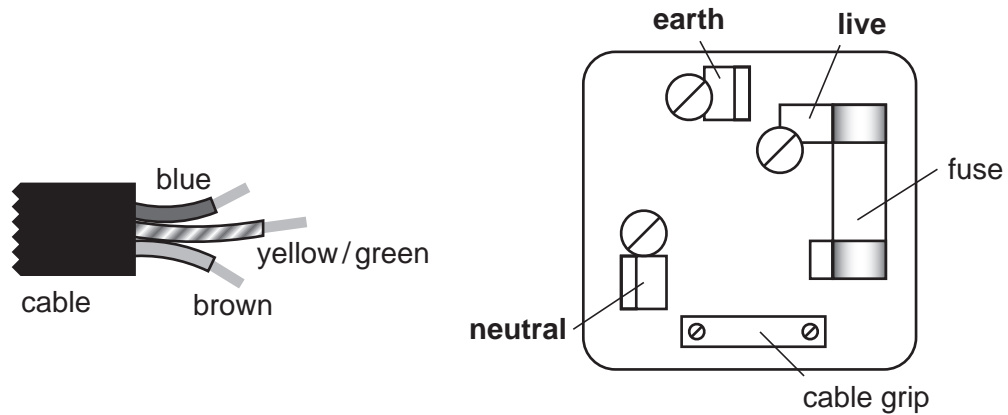

Fig. 10.1

- (a) Describe how to connect the cable and the three wires correctly and safely to the plug. [4]
- (b) The table lamp shown in Fig. 10.2 is made from plastic. It has only two wires in the cable to connect it to the plug.

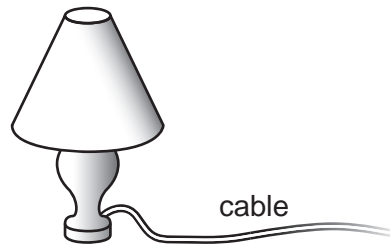

Fig. 10.2

The lamp has a power rating of 100 W and is used with a 230 V supply.

- (i) Which wire, earth, live or neutral, is **not** needed in the cable for the lamp? [1]
- (ii) Explain why the lamp is safe to use even though it has only two wires in the cable. [2]
- (iii) Explain what is meant by a *power rating of 100 W*. [2]
- (iv) Calculate the value of the fuse that should be used in the plug for this lamp. [3]
- (v) Calculate the electrical energy supplied to the lamp in 30 minutes. [3]

- 11 Stars that are being formed emit infra-red radiation. Some of this radiation is received by a telescope that orbits the Earth. Microwave signals from the telescope are sent to the Earth's surface, as shown in Fig. 11.1.

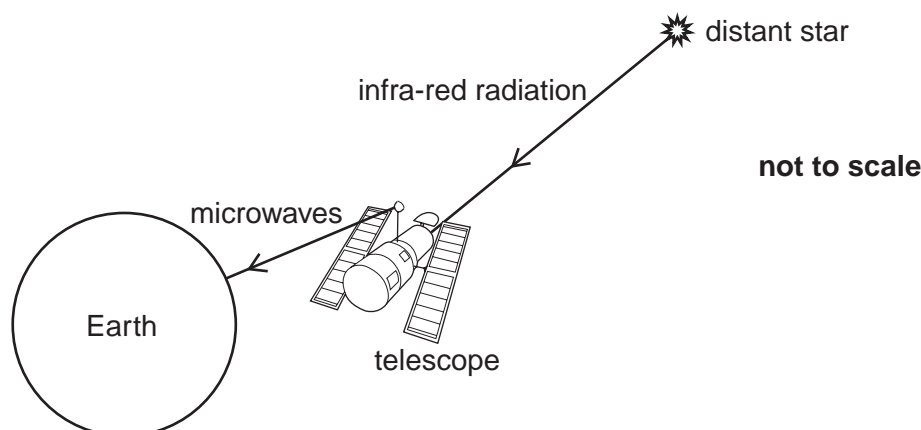

Fig. 11.1

- (a) (i) Microwaves travel at a speed of 300 000 km/s. The telescope is 600 km above the Earth's surface. Calculate the time for a microwave signal from the telescope to reach the Earth's surface. [3]
- (ii) Infra-red and microwave radiation are both part of the electromagnetic spectrum. State **two** other similarities and give **one** difference between infra-red and microwave radiation. [3]
- (b) As clouds of gas and dust come together to form a star, there is an energy change similar to the energy change as a ball falls to the ground.

The temperature in the clouds of dust and gas becomes so high that nuclear fusion occurs.

In one such reaction, two isotopes of hydrogen, ${}^2_1\text{H}$ and ${}^3_1\text{H}$, fuse together.

- (i) Explain why the gas and dust come together. [1]
- (ii) State the energy change that causes the rise in temperature as the gas and dust come together. [2]
- (iii) Explain why high temperatures are needed for nuclear fusion to occur. [2]
- (iv) Describe the structure of a nucleus of ${}^3_1\text{H}$. [2]
- (v) State which element is created by the fusion of two hydrogen nuclei. [1]
- (vi) State **one** effect of nuclear fusion on a star. [1]