PHYSICS

5054/32

Paper 3 Practical Test

May/June 2014

CONFIDENTIAL INSTRUCTIONS

Great care should be taken to ensure that any confidential information given does not reach the candidates either directly or indirectly.

No access to the Question Paper is permitted in advance of the examination.



If you have any problems or queries regarding these Instructions, please contact Cambridge
by e-mail: info@cie.org.uk,
by phone: +44 1223 553554,
by fax: +44 1223 553558,
stating the Centre number, the nature of the query and the syllabus number quoted above.

This document consists of **12** printed pages.

Instructions for preparing apparatus

These instructions detail the apparatus required for each experiment in this paper. No access is permitted to the Question Paper in advance of the examination session.

Number of sets of apparatus

In addition to a few spare sets, the minimum number of sets of apparatus to be provided should be sufficient to enable candidates to spend 20 minutes with the apparatus for each of Questions 1, 2 and 3, and one hour with the apparatus for Question 4. The order in which candidates answer the questions will be determined by the Supervisor. Candidates may spend one hour circulating around Questions 1, 2 and 3, followed by an hour on Question 4, or vice versa.

It is assumed that candidates will supply their own calculator and geometrical instruments, such as a set square, 0° to 180° protractor, pair of compasses and 30 cm rule. Candidates should be advised in advance that they may, if they wish, use quartz wristwatches with stopwatch facilities, providing that such wristwatches afford the required precision.

Instructions for the supervision of the examination

The Supervisor, who may be a Physics teacher, is responsible for the administration of the examination according to the procedures detailed in the Handbook for Centres. In all instances, a Physics teacher should be present. Preferably, this teacher should have been responsible for the preparation of the apparatus. Two invigilators must be present at all times: it is not acceptable for a teacher who has been responsible for preparing the candidates for this paper to be the sole Supervisor or Invigilator.

Supervisors may make the following announcement at the start of the examination.

'The Examiners do not want you to waste time when you are unable to do any experiment. Any candidate who is unable to get results with an experiment may ask for help. The extent of this help will be reported to the Examiners, who may make a deduction of marks.'

Supervisors should note that a candidate may only be given enough assistance to allow some raw readings or observations to be made. On no account should any assistance be given with the treatment or analysis of these readings and observations.

Supervisors may draw to the attention of the candidates any significant deviation between the apparatus provided and that detailed in the Question Paper, particularly where diagrams are given in the paper.

Candidates should be reminded that all their work should be written on the Question Paper. Rough paper must not be used.

The Supervisor must complete the Report at the back of these Instructions. Details should be given of any significant deviation between the apparatus used and that specified in these Instructions. A sample set of results can often help Examiners. A copy of this Report must be included in **each** packet of scripts.

Question 1**Items to be supplied by the Centre (per set of apparatus, unless otherwise specified)**

Pivot (see Note 1).

Stand and boss to support the pivot about 60 cm above the bench.

Half-metre rule with a millimetre scale (see Note 2).

Pulley wheel, supported about 40 cm above the bench (see Note 3).

Thin string of approximate length 70 cm (see Note 4).

10 g mass hanger with four 10 g slotted masses or 50 g mass with a suitable hook attached (see Note 5).

Metre rule with a millimetre scale.

Set square.

Notes

1. A thin rod or a round-headed nail may be used as the pivot. It must be securely held in a boss. The rod or nail should be of approximate length 8 cm to 10 cm and of approximate diameter 2 mm to 3 mm.
2. The half-metre rule should have a mass in the range 40 g to 60 g. A hole should be drilled in the rule at the 1.0 cm mark. This hole should have a diameter that is slightly greater than the diameter of the rod or nail but less than the diameter of the head if a nail is used. When the half-metre rule is suspended from the pivot it must be free to turn. A hole should also be drilled at the 49.0 cm mark. This should be of sufficient diameter to allow thin string to pass through it.
3. Candidates will need to adjust both the height of the pulley wheel and the distance between the pulley wheel and the stand holding the pivot. A suitable arrangement for holding the pulley should therefore be chosen, e.g. stand, boss and clamp.
4. One end of the thin string should be passed through the hole at the 49.0 cm mark and tied to the half-metre rule by creating a large loop at the end of the string. A second loop should be tied at the other end of the string. Supervisors should ensure that the knots do not slip. The **candidate** will pass the string over the pulley wheel and suspend the mass from the second loop, as shown in Fig. 1.1.
5. The mass requires a hook so that the candidate can suspend the mass from the loop of string. The mass should be labelled P.

6. The Supervisor should pass the pivot through the hole at the 1.0 cm mark on the half-metre rule with the scale facing the candidate. If a nail is used, the pointed end of the nail should be held in the boss. In this way the head of the nail will prevent the rule falling off the nail. The **candidate** will then set up the remainder of the apparatus as shown in Fig. 1.1.

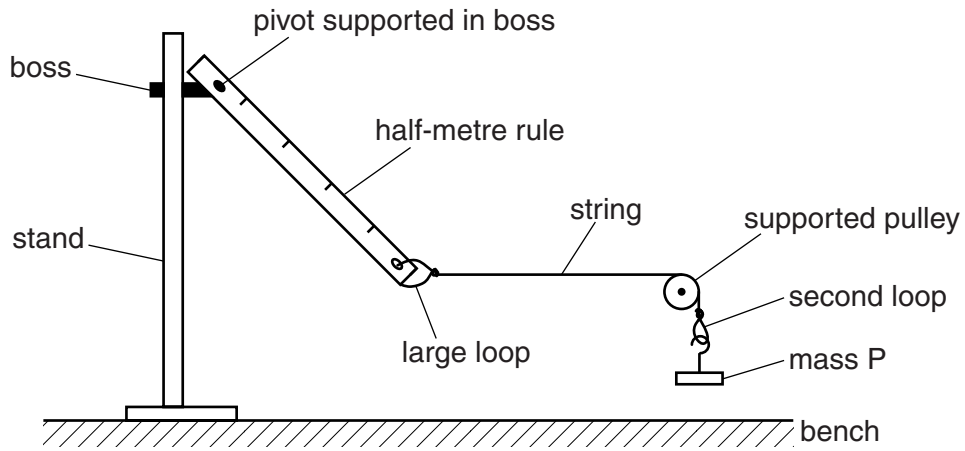

Fig. 1.1

7. Before the start of the experiment and at the changeover, the Supervisor should ensure that the string does not pass over the pulley and the mass P is removed from the second loop as shown in Fig. 1.2.

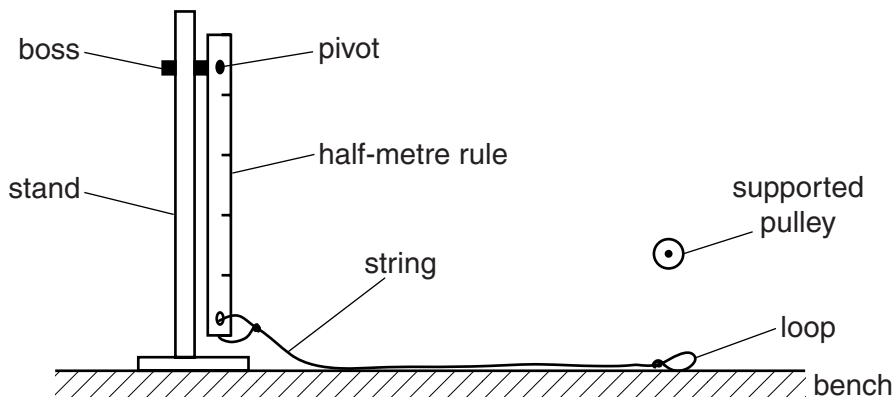

Fig. 1.2

Information required by Examiners

Sample set of numerical results, clearly marked "Supervisor's Results", obtained out of sight of the candidates.

Question 2**Items to be supplied by the Centre (per set of apparatus, unless otherwise specified)**

Converging lens of focal length 15 cm (see Note 1).

Object (see Note 2).

Screen (see Note 3).

Light source (see Note 4).

Lens holder (see Note 5).

Metre rule with a millimetre scale.

Set square.

30 cm ruler with a millimetre scale.

Notes

1. The Supervisor should ensure that each lens has a focal length between 14.5 cm and 15.5 cm. This may be done by focusing the image of a distant object on a screen. The focal length is the distance between the centre of the lens and the screen.
2. The object should be formed by using a 20 cm square piece of stiff card or board.
 - The card or board should be stiff enough to support a 15 cm ruler.
 - A horizontal slit of height 2.0 cm and length 4.0 cm should be cut in the centre of the card.
 - A 15 cm colourless and transparent ruler should then be taped horizontally across the centre of the slit so that the candidates can see the scale and the numbers.
 - The ruler must be fixed to the card in the position shown in Fig. 2.1, with 4, 5, 6 and 7 visible within the slit.
 - The side of the card to which the ruler has been attached should be labelled F.
 - Tracing paper should be attached to the back of the card to cover the slit.
 - If a 15 cm ruler is not available, Supervisors may use a 30 cm colourless and transparent ruler, and should tell candidates to ignore the protrusions beyond the card.

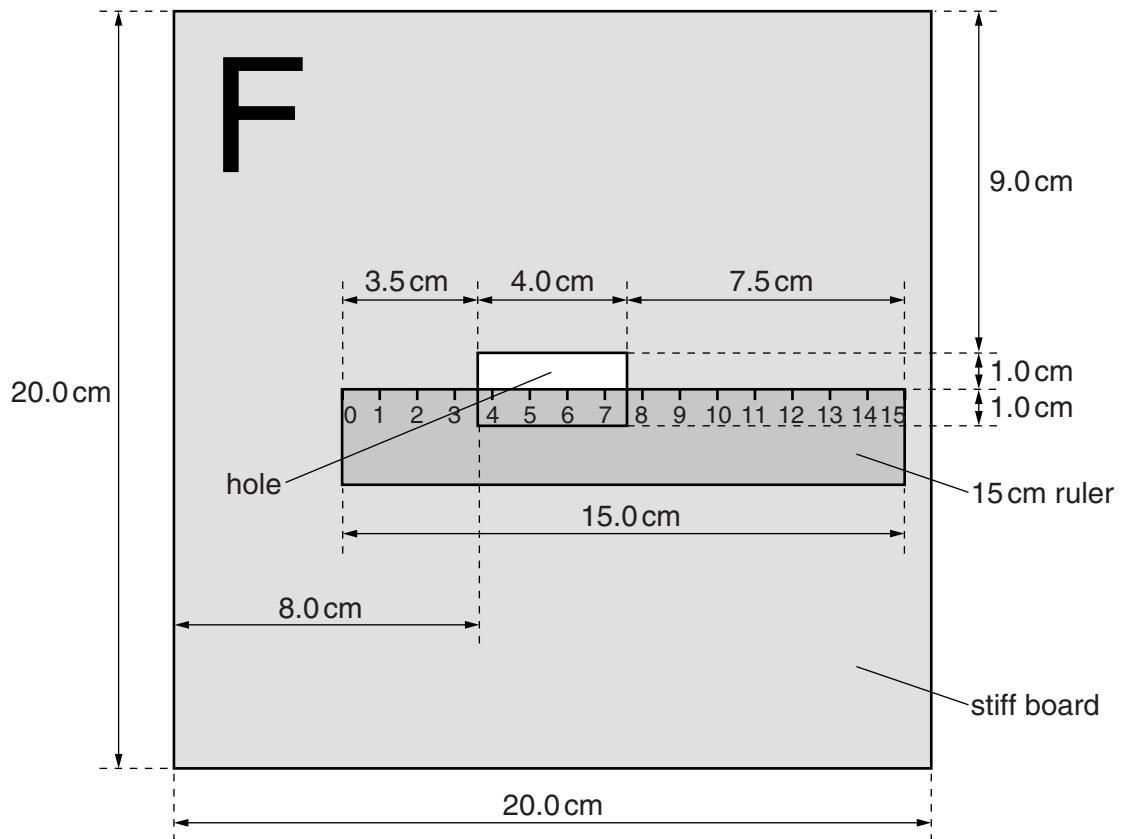

Fig. 2.1

3. The screen should be formed by using a 20 cm square piece of card or board. The screen should have a white surface. The object and the screen should be supported so that they can stand perpendicular to the bench. This may be done by attaching blocks of wood to the base of the object and screen.
4. The apparatus should be in a dimly lit area of the laboratory and the light source should be bright enough so that candidates can see an image of the object, magnified by a factor of approximately 5, formed on the screen.
5. The centre of the object, the light source and the centre of the lens when it is supported in the holder should all be at the same height above the bench. The **candidate** will set up the arrangement shown in Fig. 2.2.

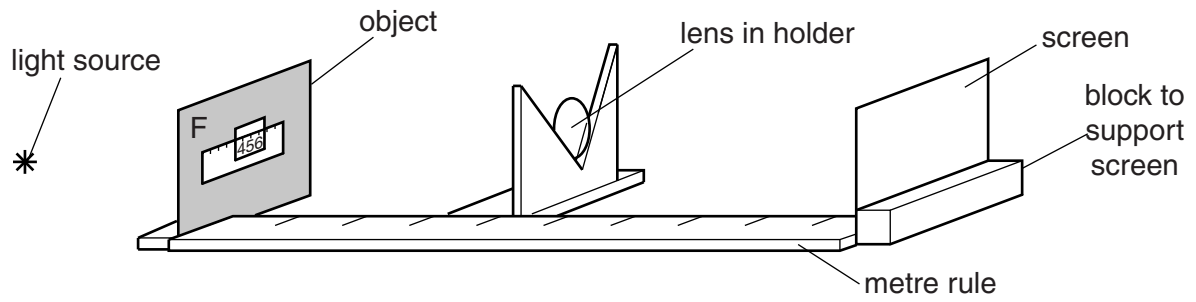

Fig. 2.2

6. Before the start of the experiment and at the changeover, the Supervisor should place the object and screen less than 1 m apart.

Information required by Examiners

Sample set of numerical results, clearly marked "Supervisor's results", obtained out of sight of the candidates.

Question 3**Items to be supplied by the Centre (per set of apparatus, unless otherwise specified)**

Power source (see Note 1).

Switch or plug key.

Ammeter capable of measuring a current up to 200 mA to a precision of 1 mA or better. An analogue or digital meter is suitable.

Voltmeter capable of measuring a potential difference up to 2.0 V to a precision of 0.01 V or better. An analogue or digital meter is suitable.

Two $27\ \Omega$ resistors labelled R_1 and R_2 (see Note 2).

Four connecting leads to enable the Supervisor to set up the circuit shown in Fig. 3.1. The points A and B should be labelled.

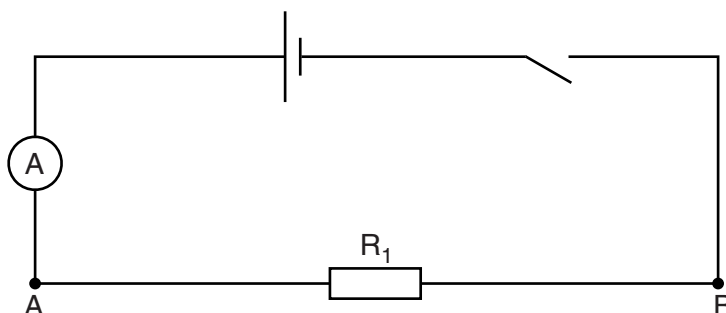

Fig. 3.1

A further four connecting leads to enable the **candidate** to connect the voltmeter and the resistor R_2 to the circuit across AB. See Note 3.

Notes

- The following are suitable power sources but all the candidates at a Centre must be supplied with the same source:
 - 1.5 V dry cell in a suitable holder,
 - 1.2 V rechargeable cell in a suitable holder,
 - d.c. power supply of e.m.f. 1.5 V or 2 V.
 If a d.c. power supply is used, the Supervisor should tell candidates that a d.c. power supply has been used instead of the cell shown on the circuit diagram. If a variable d.c. power supply is used, the variable control should be taped to prevent candidates altering the output voltage.
- The resistors should have suitable terminals to enable them to be connected to the remainder of the circuit. Even though they are identical, they should have labels R_1 and R_2 . A power rating of 0.25 W or greater is suitable, e.g. RS Components product code 707-7546.
- The Supervisor should ensure that it is possible to measure the potential difference between A and B with the voltmeter.

4. Before the start of the experiment and at the changeover, the Supervisor should set up the circuit as shown in Fig. 3.1. The resistor R_2 , the voltmeter and the further four connecting leads should be laid out on the bench.

Information required by Examiners

Type and e.m.f. of power source, e.g. “rechargeable cell, 1.2V”.

Sample set of numerical results, clearly marked “Supervisor’s Results”, obtained out of sight of the candidates.

Question 4**Items to be supplied by the Centre (per set of apparatus, unless otherwise specified)**

100 cm³ Pyrex beaker (see Note 1).

Supply of hot water (see Note 2).

100 cm³ measuring cylinder.

Thermometer with a range of –10 °C to 110 °C.

Stand, boss and clamp to support the thermometer.

Stirrer (see Note 3).

Stopwatch.

Paper towels to mop up spillages.

Notes

1. An adhesive label should be attached to the beaker so that the top of the label is at the level of a volume of 80 cm³ of water in the beaker. The mass of the empty beaker, to the nearest gram, should be written on this label in the form “ $m = \dots\dots\dots \text{g}$ ”.
2. The supply of hot water could be from a kettle that has just boiled. The supply may be shared between several candidates. The Supervisor should inform candidates how to safely transfer the hot water to their work station. Each candidate will need approximately 80 cm³ of the hot water.
3. The stirrer may be a glass rod, a plastic rod or spoon, or a wooden rod. The stirrer must not be metal.
4. At the changeover the Supervisor should:
 - ensure sufficient recently boiled hot water is available for the next candidate,
 - empty the beaker and then dry it,
 - remove the thermometer from the clamp,
 - replace wet paper towels with dry ones.

Information required by Examiners

Sample set of numerical results, clearly marked “Supervisor’s Results”, obtained out of sight of the candidates.

Permission to reproduce items where third-party owned material protected by copyright is included has been sought and cleared where possible. Every reasonable effort has been made by the publisher (UCLES) to trace copyright holders, but if any items requiring clearance have unwittingly been included, the publisher will be pleased to make amends at the earliest possible opportunity.

Cambridge International Examinations is part of the Cambridge Assessment Group. Cambridge Assessment is the brand name of University of Cambridge Local Examinations Syndicate (UCLES), which is itself a department of the University of Cambridge.

This form must be completed and returned with the candidates' scripts.

REPORT ON PRACTICAL PHYSICS

The Supervisor is asked to give the following details, using the space provided on page 12.

- (a) Information required at the end of the test, as indicated in the Instructions.
- (b) Any help given to a candidate.
- (c) Any general difficulties encountered in preparing the apparatus.
- (d) Any difficulties experienced by particular candidates. These should include reference to difficulties due to faulty apparatus or materials and accidental damage to apparatus or materials. Candidates should be identified by name and candidate number.

Other cases of hardship, such as disability or illness, should be reported to Cambridge in the normal way.

The Supervisor is asked to provide a plan of the work benches, giving details by candidate numbers of the places occupied by the candidates for each session. The plan and report should be enclosed in the envelope containing the candidates' scripts. If more than one envelope is used, a copy of the report must be enclosed in each envelope.

Declaration to be signed by the Principal

The preparation of this practical examination has been carried out so as to maintain fully the security of the examination.

Signed

Name (in block capitals)

Centre number

Centre name



Information required

1. Type and e.m.f. of power source used in Question 3.

.....

2. For each question, please enclose a sample set of numerical results, obtained out of sight of the candidates and clearly labelled "Supervisor's Results".

Details of difficulties and any help given to candidates

